



High Precision Regulators

R210 / R220 / R230 Series

Catalogue no. PDE2542TCUK-ca





WARNING

FAILURE OR IMPROPER SELECTION OR IMPROPER USE OF THE PRODUCTS AND/OR SYSTEMS DESCRIBED HEREIN OR RELATED ITEMS CAN CAUSE DEATH, PERSONAL INJURY AND PROPERTY DAMAGE.

This document and other information from Parker Hannifin Corporation, its subsidiaries and authorized distributors provide product and/or system options for further investigation by users having technical expertise. It is important that you analyze all aspects of your application and review the information concerning the product or system in the current product catalog. Due to the variety of operating conditions and applications for these products or systems, the user, through its own analysis and testing, is solely responsible for making the final selection of the products and systems and assuring that all performance, safety and warning requirements of the application are met. The products described herein, including without limitation, product features, specifications, designs, availability and pricing, are subject to change by Parker Hannifin Corporation and its subsidiaries at any time without notice.

SALE CONDITIONS

The items described in this document are available for sale by Parker Hannifin Corporation, its subsidiaries or its authorized distributors. Any sale contract entered into by Parker will be governed by the provisions stated in Parker's standard terms and conditions of sale (copy available upon request).

R210 / R220 High Precision Regulator

Features	4
Applications	4
Dimensions	4
Ordering Information	4
Technical Information	5
Kits & Accessories	5
Materials of Construction	5
Specifications	5

R230 High Flow Precision Regulator

Features	6
Applications	6
Dimensions	6
Ordering Information	6
Technical Information	7
Kits & Accessories	7
Materials of Construction	7
Specifications	7

High Precision Regulators

R210 / 220 High Precision Regulator

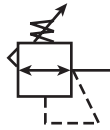

Features

- Accurate Pressure Regulation. Controls Output Pressure to within 0.1% Accuracy.
- Multi-Stage Regulation for Maximum Control and Stability.
- Two Full Flow Gauge Ports.
- Super Sensitive Relief. Downstream Pressure Buildup, Down to 0.3m bar Above the Set Pressure, is Automatically Vented through Internal Relief Valve.
- R220 has High Exhaust Relief Capacity.

Applications

The R210 and R220 regulators are well suited for any process that requires very precise regulation of air pressure in pipes and vessels. These regulators are often used, but not limited to the following applications:

- Air Gauging
- Gas Mixing
- Calibration Standards
- Air Hoists
- Web Tensioning
- Gate Actuators
- Roll Loading
- Valve Operators
- Cylinder Loading

R210 / R220 Regulator Dimensions		
A	B	C
52mm	110mm	97mm
D		
13.5mm		

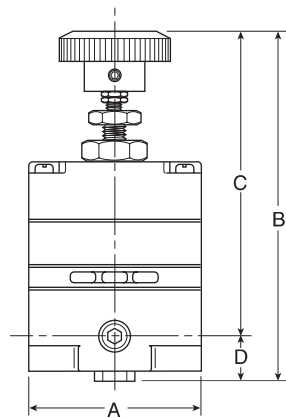

⚠ WARNING

Do not connect regulator to bottled gas.

Do not exceed maximum primary pressure rating.

Product rupture can cause serious injury.

The R210 / R220 are high precision, multi-stage pressure regulators. This pressure controller provides the highest level of regulation accuracy and repeatability available and is ideal for applications that call for the utmost in control and maximum stability under variable operating conditions. A stainless steel measuring capsule is used as a sensing element to activate the high gain servo balanced control mechanism in which the main valve is controlled by a pilot valve. This allows for greater accuracy and eliminates many of the problems associated with conventional regulators using range springs and diaphragms.

Ordering Information

		Reduced Pressure Range (Bar)		
Relieving		0.13 to 2.7	0.13 to 8.2	0.13 to 8.2 High Relief
In / Out Ports	1/4"	R210G02A	R210G02C	R220G02C

Technical Information

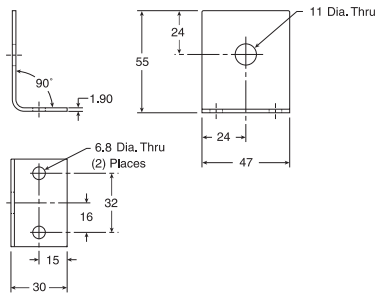
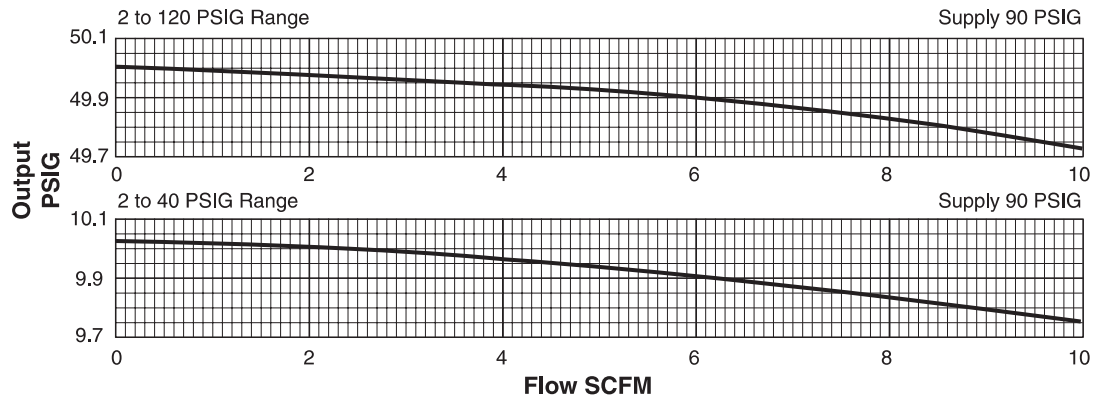

Mounting Bracket: 446-707-045

R210 / R220 Regulator Kits & Accessories

Mounting Bracket Kits

- Pipe Mounting **SA200YW57**
- Right Angle Mounting **446-707-045**

Service Kits

- 0.13 to 2.7 bar **RKR210A**
- 0.13 to 8.2 bar **RKR210C**
- 0.13 to 8.2 bar (High Relieving) **RKR220C**

Materials of Construction

- Adjusting Stem & Capsule Stainless Steel
- Body Zinc
- Control Knob Plastic
- Diaphragm(s) Buna-N
- Seals Buna-N
- Springs Stainless Steel
- Valve Poppet Stainless Steel

Specifications

- Constant Bleed Rate Less than 0.15m³/hr
(Equals Bleed Rate plus other consumption)
- Total Air Consumption 0.21m³/hr.
- Effect of Supply Pressure Variation
of 1.7 bar on outlet: Less than 0.3m bar
- Exhaust (Relief) Capacity
At 0.34 bar above 1.38 bar Setpoint
Standard Model 3.4m³/hr
High-Relief Model 17m³/hr
- Flow Capacity
At 9 bar Supply,
1.38 bar Outlet 25m³/hr
- Gauge Ports 1/4"
(Can be used as additional full flow 1/4" outlet ports)
- Operating Pressure Range: bar
- PRIMARY – Maximum 10
- SECONDARY – Spring Pressure
2.7 bar Minimum 0.14
Maximum 2.70
8.2 bar Minimum 0.14
Maximum 8.2
- Operating Temperature Range -18°C * to 65°C
* Temperatures below 0°C require moisture free air.
- Repeatability / Sensitivity 0.3m bar
Inches of Water Column = 1/8"
- Weight 640g

High Flow Precision Regulators

R230 High Flow Precision Regulator

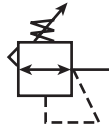

Features

- Adjusting Knob.
- Diaphragm Design for Good Repeatability, Response and Sensitivity.
- Balanced Poppet.
- Two Full Flow Gauge Ports.
- Precise Regulation. Will Sense a Decrease in Downstream Pressure as Small as 1/4" of Water.
- High Flow Capacity. Flows of 37.8dm³/s Attainable with Minimal Drop.
- Stable Output. Dampening Action of Aspiration Tube makes Regulator Insensitive to Changes in Flow.
- On-line Maintenance. Can be Serviced Without Removal of Air Line.

Applications

The R230 regulators are an ideal choice for any application that calls for accurately maintained output pressure under high flow conditions. This includes, but is not limited to such applications as:

Test Equipment

- Gas Mixing
- Valve Operators
- Positioning Cylinders
- Laboratory Equipment
- Web Tensioning
- Clutch & Brake Controls
- Roll Loading
- Test Panels
- Actuators

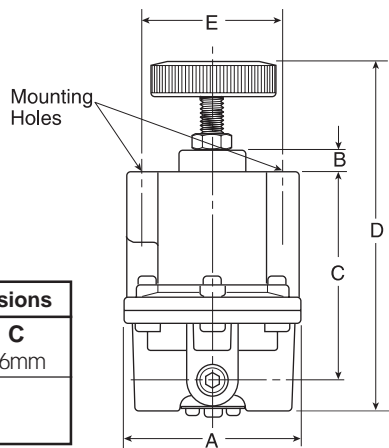

R230 Regulator Dimensions		
A	B	C
76mm	10mm	86mm
D	E	
154mm	57mm	

⚠ WARNING

Do not connect regulator to bottled gas.

Do not exceed maximum primary pressure rating.

Product rupture can cause serious injury.

The R230 is designed for applications that require high flow capacity and accurate process control. A poppet valve which is balanced by utilizing a rolling diaphragm, insures a constant output pressure even during wide supply pressure variations. Stability of regulated pressure is maintained under varying flow conditions through the use of an aspirator tube which adjusts the air supply in accordance with the flow velocity.

Ordering Information

		Reduced Pressure Range (Bar)			
Relieving		0 to 0.13	0 to 2	0 to 4	0 to 10
In / Out Ports	1/4"	R230G02E	R230G02B	R230G02C	R230G02D

High Flow Precision Regulators

Technical Information

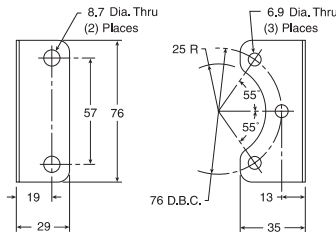
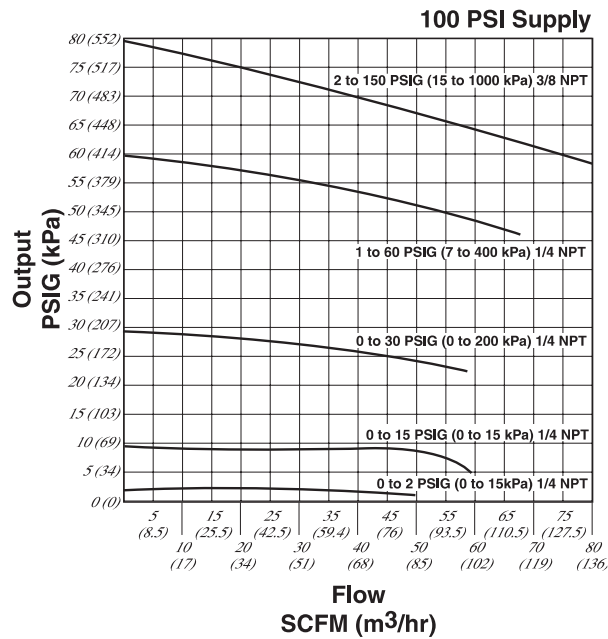

Mounting Bracket: 446-707-025

R230 Regulator Kits & Accessories

Mounting Bracket Kit **446-707-025**

Service Kits – Relieving

- 0 to 0.13 bar **RKR230E**
- 0 to 2 bar **RKR230B**
- 0 to 4 bar **RKR230C**
- 0 to 10 bar **RKR230D**

Materials of Construction

- Adjusting Stem & Spring Steel
- Biased Spring Stainless Steel
- Body, Bonnet Aluminum
- Control Knob Plastic
- Diaphragm Buna-N Elastomer and Polyester Fabric
- Seals Buna-N
- Valve Poppet Brass
- Valve Poppet Seat Buna-N

Specifications

- Constant Bleed Rate upto 0.35m³/h
(Depending upon output pressure)
- Gauge Ports Two Ports 1/4"
(Can be used as additional Full Flow 1/4 Inch Outlet Ports)
- Effect of Supply Pressure Variation –
Less than 6mbar for 6.89 bar change
- Exhaust (Relief) Capacity –
1.88 dm³/s with downstream pressure 0.3 bar above set pressure. Exhaust commences at 0.7m bar above set pressure.
- Flow Capacity –
At 6.89 bar Supply,
5.5 bar Outlet 37.8 dm³/s
- Operating Temperature Range – -40°C to 71°C
- Operating Pressure Range – bar
PRIMARY – Maximum 17
- Port Threads 1/4"
- Exhaust (Relief) Capacity 1.88 dm³/s
(Downstream pressure 0,3 bar above set pressure)
- Repeatability / Sensitivity 6m bar
Inches of Water Column = 1/4"
- Response 250 ms
The valve will open to full flow and fill a volume of 1250 cm³
- Weight 740g

Pneumatic Division Sales Offices

Austria - Wr.Neustadt

Tel: +43 2622 23501
Fax: +43 2622 66212

Belgium - Nivelles

Tel: +32 67 280 900
Fax: +32 67 280 999

**Czech & Slovak
Republics - Klecany**

Tel: +420 284 083 111
Fax: +420 284 083 112

Denmark - Ballerup

Tel: +45 43 560400
Fax: +45 43 733107

Finland - Vantaa

Tel: +358 9 4767 31
Fax: +358 9 4767 3200

France - Contamine

Tel : +33 4 50 25 80 25
Fax : +33 4 50 03 67 37

Germany - Kaarst

Tel: +49 2131 4016-0
Fax: +49 2131 4016-9199

Greece - Athens

Tel: +30 210 933 6450
Fax: +30 210 933 6451

Hungary - Budapest

Tel: +36 1 220 4155
Fax: +36 1 422 1525

Ireland - Dublin

Tel: +353 1 293 9999
Fax: +353 1 293 9999

Italy - Corsico, Milan

Tel: +39 02 4519 21
Fax: +39 02 4479 340

Netherlands - Oldenzaal

Tel: +31 541 585000
Fax: +31 541 585459

Norway - Langhus

Tel: +47 6491 1000
Fax: +47 6491 1090

Poland - Warsaw

Tel: +48 22 863 49 42
Fax: +48 22 863 49 44

**Portugal - Leça da
Palmeira**

Tel: +351 22 999 7360
Fax: +351 22 996 1527

Romania - Bucharest

Tel: +40 21 252 1382
Fax: +40 21 252 3381

Russia - Moscow

Tel: +7 095 234 0054
Fax: +7 095 234 0528

Slovenia - Novo mesto

Tel: +386 7337 6650
Fax: +386 7337 6651

Spain - Madrid

Tel: +34 91 675 7300
Fax: +34 91 675 7711

Sweden - Spånga

Tel: +46 (0) 8 5979 5000
Fax: +46 (0) 8 5979 5120

Switzerland

Tel: +49 2131 4016-0
Fax: +49 2131 4016-9199

Turkey - Istanbul

Tel: +90 212 482 91 06
Fax: +90 212 482 91 10

UK - Cannock

Tel: +44 1543 456000
Fax: +44 1543 456001

Ukraine - Kiev

Tel: + 380 44 220 7432
Fax: + 380 44 220 6534



Parker Hannifin plc

Pneumatic Division,
Walkmill Lane, Bridgtown,
Cannock, Staffs. WS11 0LR
United Kingdom