

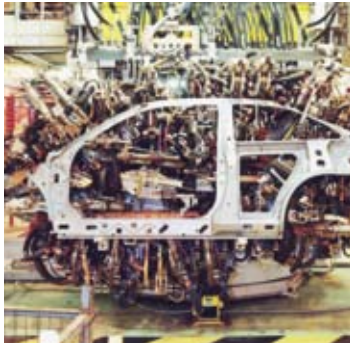

aerospace
 climate control
 electromechanical
 filtration
 fluid & gas handling
 hydraulics
pneumatics
 process control
 sealing & shielding



Poppet Valves

Heavy duty poppet valves
 G3/8, G1/2 - 2/2, 3/2

Catalogue PDE2630TCUK. Edition August 09



ENGINEERING YOUR SUCCESS.

Heavy duty poppet valves

Material Specification.....	3
Operating Information.....	3
Order key.....	4
Flow Characteristics.....	5
Main Data Mechanically Operated Valves.....	6 - 7
Dimensions.....	8 - 9
Solenoid Operators	10
Cable Plugs.....	11
Accessories.....	11



Important !
 Before carrying out any service work, ensure that the valve and manifold have been vented. Remove the primary supply air hose to ensure total disconnection of the air supply before dismantling valves or blank connection blocks.



NB !
 All technical data in this catalogue is typical only. The air quality is decisive for the valve life: see ISO 8573.



WARNING

FAILURE OR IMPROPER SELECTION OR IMPROPER USE OF THE PRODUCTS AND/OR SYSTEMS DESCRIBED HEREIN OR RELATED ITEMS CAN CAUSE DEATH, PERSONAL INJURY AND PROPERTY DAMAGE.
 This document and other information from Parker Hannifin Corporation, its subsidiaries and authorized distributors provide product and/or system options for further investigation by users having technical expertise. It is important that you analyze all aspects of your application and review the information concerning the product or system in the current product catalog. Due to the variety of operating conditions and applications for these products or systems, the user, through its own analysis and testing, is solely responsible for making the final selection of the products and systems and assuring that all performance, safety and warning requirements of the application are met. The products described herein, including without limitation, product features, specifications, designs, availability and pricing, are subject to change by Parker Hannifin Corporation and its subsidiaries at any time without notice.

SALE CONDITIONS

The items described in this document are available for sale by Parker Hannifin Corporation, its subsidiaries or its authorized distributors. Any sale contract entered into by Parker will be governed by the provisions stated in Parker's standard terms and conditions of sale (copy available upon request).

Heavy duty poppet valves

Heavy duty poppet valves

2/2 & 3/2 - G³/₈" & G¹/₂"

These valves use the well proven poppet principle to give high flow rates with short valve travel, both the 2/2 and 3/2 valves in the range are available in G³/₈" and G¹/₂" port sizes. This means that each actuator is available in four configurations i.e. 3/8" ports 2/2 or 3/2 and G¹/₂" ports 2/2 or 3/2. All valves are normally closed.

The bodies are of block form construction for ease of mounting. Springs are stainless steel; internal seals being of nitrile rubber. The 2/2 body allows air in one direction only, 3/2 versions having the facility of exhausting air through the actuator unit. This exhaust vent is un-threaded on all valves except the pilot and solenoid types which allows the piping away of exhaust air.

All mechanisms are spring returned.

Working medium, air quality

Working medium: Dry, filtered compressed air to ISO 8573-1 class 3.4.3.

Recommended air quality for valves

For best possible service life and trouble free operation, ISO 8573-1 quality class 3.4.3 should be used. This means 5µm filter (standard filter) dew point +3°C for indoor operation (a lower dew point should be selected for outdoor operation) and oil concentration 1.0 mg oil/m³, which is what a standard compressor with a standard filter gives.

ISO 8573-1 quality classes

Quality class	Pollution		Water max. press. dew point (°C)	Oil max. concentration (mg/m ³)
	particle size (µm)	max. concentration (mg/m ³)		
1	0,1	0,1	-70	0,01
2	1	1	-40	0,1
3	5	5	-20	1,0
4	15	8	+3	5,0
5	40	10	+7	25
6	-	-	+10	-

Specification

Material

Body	Zinc die cast
Roller	Zinc plated steel
Mechanical arm	Zinc plated steel
Poppet	Stainless steel
Seals	Nitrile
Spring	Stainless steel
Bush	Aluminium
Piston	Aluminium

Operating information

Working pressure	0 - 10 bar
Working temperature	-10°C to +80°C
Solenoid version	-10°C to +50°C
Minimum pilot pressure	1.9 bar @ 6 bar supply
Response time (solenoid energised)	14 msec
Response time (solenoid de-energised)	75 msec

Flow capacities in accordance with ISO6358

	B102-B103	B202-B203
Flow;	C = 7,54	C = 10,75 NI/s x bar
	b = 0,29	b = 0,24
	Qn = 33 l/s	Qn = 43 l/s
	Qmax = 54 l/s	Qmax = 75 l/s
	Cv = 2,65	Cv = 3,20

Part number configurator for solenoid valves

Valve family	
DB	HD poppet solenoid operated

Thread port	
1	3/8 BSP
2	1/2 BSP

Air supply to solenoid	
2	Internal

Function	
2	2/2 NC
3	3/2 NC

Overrides	
A	None
C	Flush - Locking
D	Extended - non locking

Voltage ¹			
	AC		DC
	60Hz	50Hz	
40	12		
42	24	22	
45			12
49			24
53	120	110	
57	240	230	
XX	valve less solenoid/coil		

¹ Shaded part numbers are standard
 Unshaded part numbers are available on request but will be subject to minimum order quantities
 Otherwise order XX version and order coil separately.

Part number configurator for manual & mechanical operated poppet valves

Valve family	
B	HD poppet manual & mechanical

Thread port	
1	3/8 BSP
2	1/2 BSP

Function	
2	2/2 NC
3	3/2 NC

Operator	
C	Ball
L	Lever
P	Pilot pressure
R	Roller lever

Flow characteristics

Flow capacities in accordance with ISO6358
 Flow measured with valve on manifold
 All pressures = effective pressure

B102

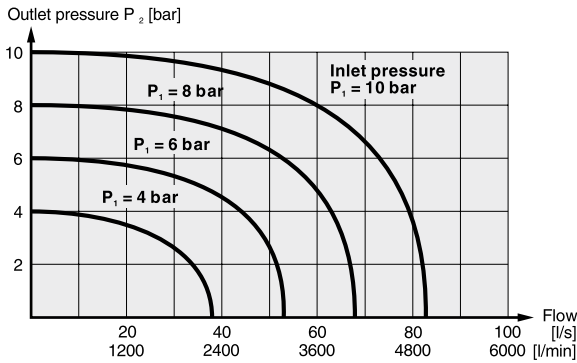

B202

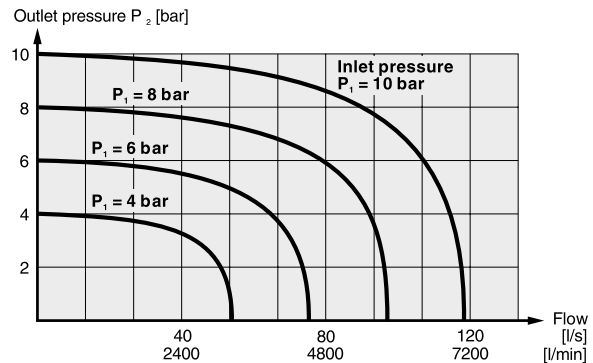

Electrical Information

Power consumption	Inrush	Hold
	AC VA	8.5VA
	DC 4.8 Watt	
Rating	100% continuous	
Isolation class	F	
Protection class	IP 65 (P 54) DIN 40 050	
Connection	DIN 43 650 Form B	
Solenoid response	milliseconds at 7 bar	

External pilot supply option





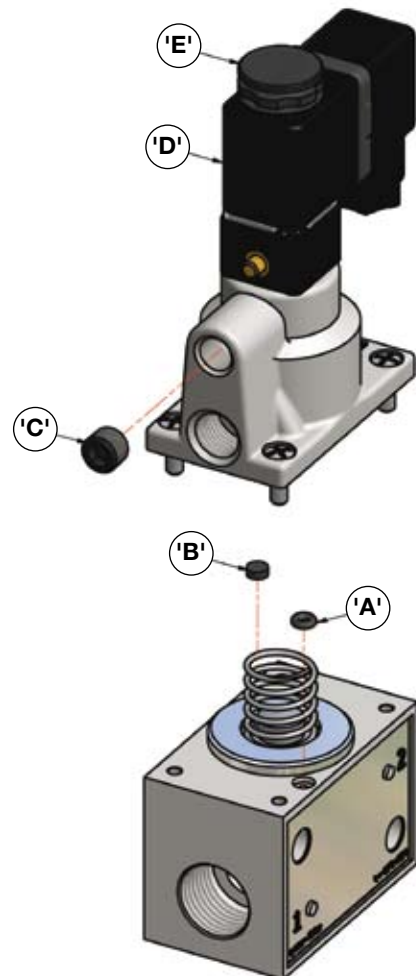

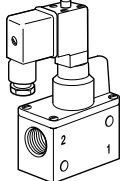

Solenoid pilot operated valves have an internal pilot air supply, but provisions for external pilot supply is provided. To use with external supply interchange 'O'-ring (Item 'A') and Plug (Item 'B') to block off the internal pilot supply. Remove hexagon socket plug (Item 'C') from the external pilot supply port, connecting an air supply as desired.

Orientation of the solenoid coil (Item 'D') can be altered through 90° increments by loosening the diffuser nut (Item 'E').

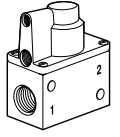

Heavy duty poppet valves



Main data for mechanically operated valves, Heavy duty poppet series (NC only)

Symbol	Type	Connection	Actuator	Return	Voltage	Weight Kg	Order code	
		2/2	G3/8	Solenoid pilot	Spring	24VDC Less solenoid	0.70 0.65	DB122A49 DB122AXX
		3/2	G3/8	Solenoid pilot	Spring	24VDC Less solenoid	0.70 0.65	DB123A49 DB123AXX
		2/2	G1/2	Solenoid pilot	Spring	24VDC Less solenoid	0.70 0.65	DB222A49 DB222AXX
		3/2	G1/2	Solenoid pilot	Spring	24VDC Less solenoid	0.70 0.65	DB223A49 DB223AXX
		2/2	G3/8	Air pilot	Spring		0.61	B102P
		3/2	G3/8	Air pilot	Spring		0.61	B103P
		2/2	G1/2	Air pilot	Spring		0.61	B202P
		3/2	G1/2	Air pilot	Spring		0.61	B203P

Order electrical connectors for solenoids separately. See page 10

Heavy duty poppet valves

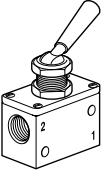
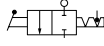
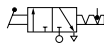
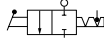
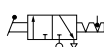
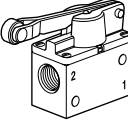
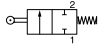
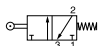
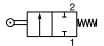
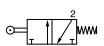
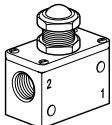
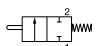
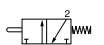
Main data for mechanically operated valves, Heavy duty poppet series (NC only)

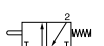
	Symbol	Type	Connection	Actuator	Return	Operating force at 6 bar, N	Weight Kg	Order code
		2/2	G3/8	Lever	Lever	22	0.65	B102L
		3/2	G3/8	Lock down lever	Lever	22	0.65	B103L
		2/2	G1/2	Lock down lever	Lever	22	0.65	B202L
		3/2	G1/2	Lock down lever	Lever	22	0.65	B203L
		2/2	G3/8	Roller lever	Spring	36	0.642	B102R
		3/2	G3/8	Roller lever	Spring	36	0.630	B103R
		2/2	G1/2	Roller lever	Spring	36	0.614	B202R
		3/2	G1/2	Roller lever	Spring	36	0.604	B203R
		2/2	G3/8	Ball	Spring	220	0.542	B102C
		3/2	G3/8	Ball	Spring	220	0.532	B103C
		2/2	G1/2	Ball	Spring	220	0.530	B202C
		3/2	G1/2	Ball	Spring	220	0.520	B203C

Mechanically operated valves - 2/2, 3/2 valves

Basic body dimensions

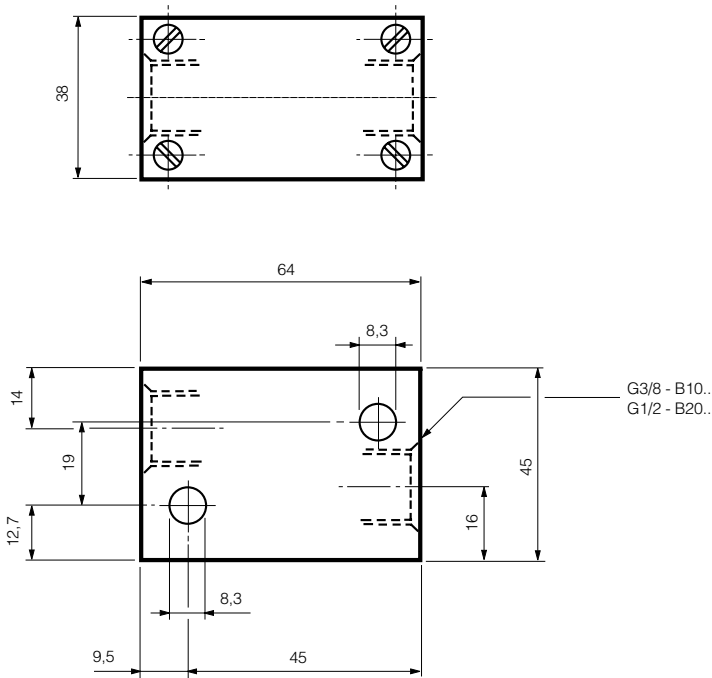

Solenoid pilot operated spring return

DB122, DB123, DB222, DB223

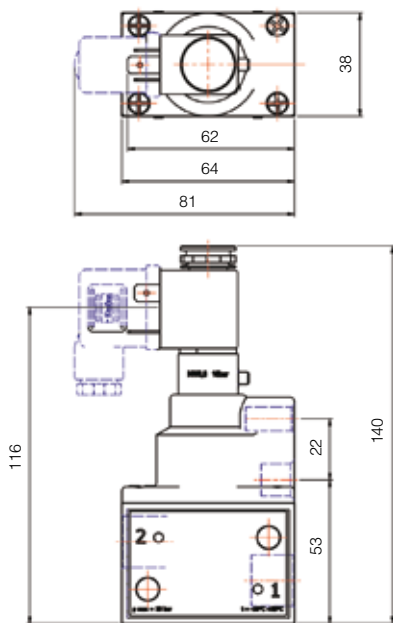

Air pilot operated spring return

B102P, B103P, B202P, B203P

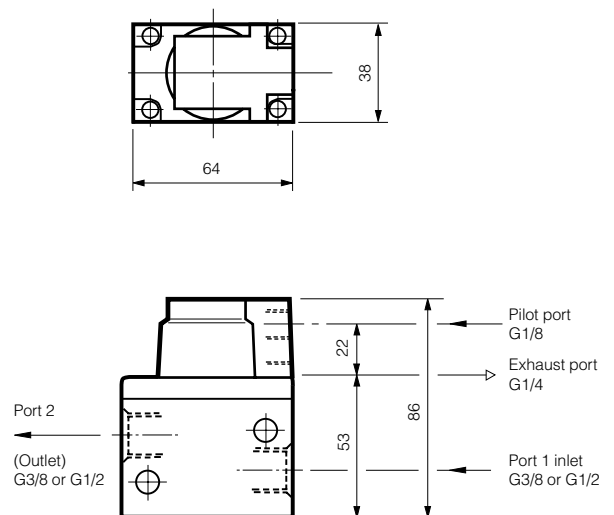

All dimensions in mm unless otherwise stated

Mechanically operated valves - 2/2, 3/2 valves

Lock down lever
 B102L, B103L, B202L, B203L

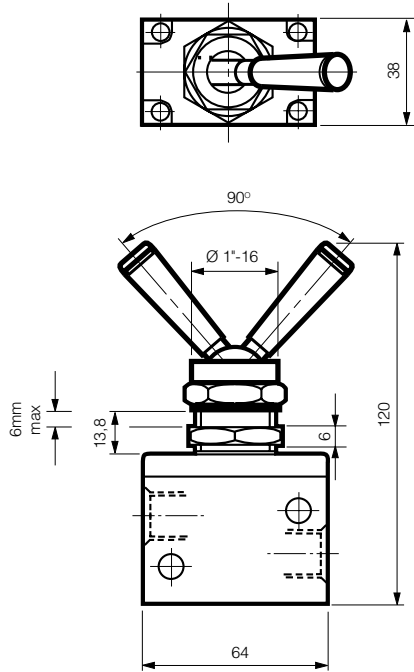

Roller lever operated spring return
 B102R, B103R, B202R, B203R

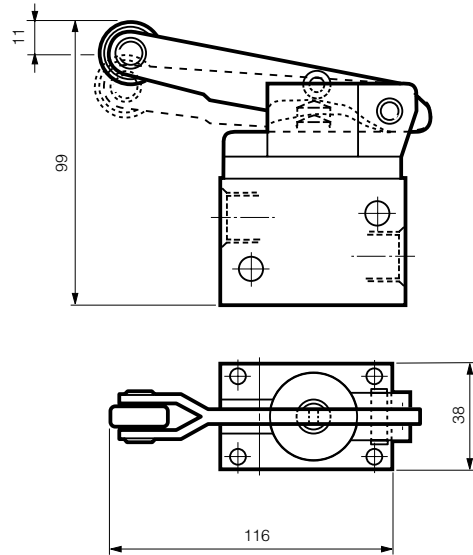

Ball operated spring return
 B102C, B103C, B202C, B203C

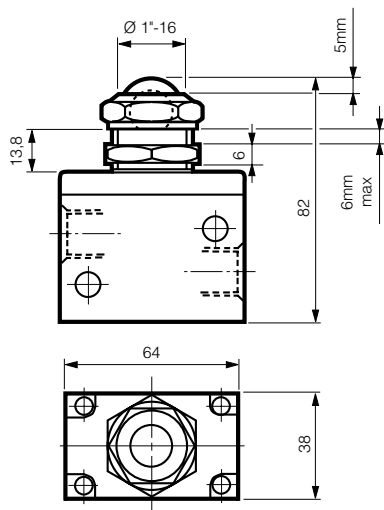

All dimensions in mm unless otherwise stated

22mm solenoid operator part numbers and spares

Solenoid coils for 22mm solenoid operators

Voltage	Order code Form B	Weight (Kg)
12V 60Hz	P2FCB440	0.093
24V 50/60Hz	P2FCB442	0.093
12V DC	P2FCB445	0.093
12V DC Mobile	P2FCB447	0.093
24v DC Mobile	P2FCB448	0.093
24V DC	P2FCB449	0.093
48V DC	P2FCB451	0.093
110V/50Hz, 120V/60Hz	P2FCB453	0.093
230V/50Hz, 230V/60Hz	P2FCB457	0.093

Spare Solenoid Nuts

Valves with vented exhaust are fitted with diffuser plastic nut

Order Code
P2FND

Spare Solenoid Operators

Solenoid pilot operator 22mm NC, Normal duty (Max Operating pressure 10bar, Temp -10°C to +50°C)

Order code (with locking bi-stable m/o)	Weight Kg
P2FP13N4C	0.05
Order code (with Non-locking monostable m/o)	Weight Kg
P2FP13N4D	0.05
Order code (with no m/o)	Weight Kg
P2FP13N4A	0.05

Note.

The operators are supplied with mounting screws and interface 'O' rings.

Coils and connectors must be ordered separately.

Solenoid Connectors / Cable Plugs EN175301-803

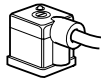
	Description	Order code 22mm Industrial Form B
With standard screw 	Standard IP65 without flying lead	3EV10V10
	With LED and protection 24V AC/DC	3EV10V20-24
	With LED and protection 110V AC	3EV10V20-110
	With LED and protection 230V AC	3EV10V20-230
With cable 	24V AC/DC, 5m cable LED and protection IP65	3EV10V20-24L5
	110V AC/DC, 5m cable LED and protection IP65	3EV10V20-110L5
	230V AC, 5m cable LED and protection IP65	3EV10V20-230L5

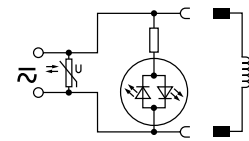
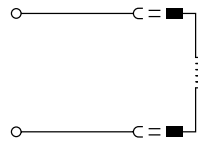

3EV10V10	3EV10V20-24	3EV10V20-24L5
	3EV10V20-110	3EV10V20-110L5
	3EV10V20-230	3EV10V20-230L5

Cable Plug Dimensions (mm)

Solenoid operators P2E-•V...

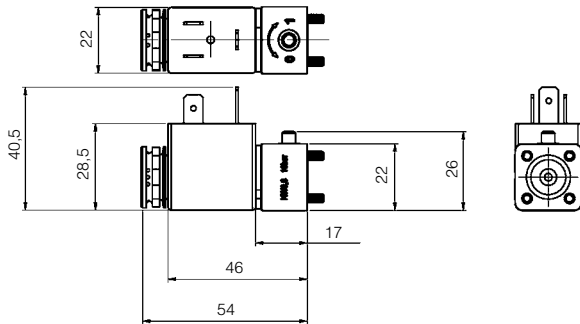

Cable plugs Form B

3EV10V10

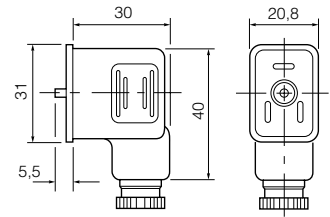

Accessories

Sintered bronze series silencers

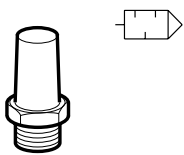

Port	Order code	Pack Qty
G1/4	P6M-BAA2	1

Male straight connectors - Parallel thread

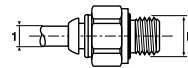

Tube Ø1	Thread B	Order code	Box Qty
4	1/8	F4PMB4-1/8	20
6	1/8	F4PMB6-1/8	30
6	1/4	F4PMB6-1/4	30
8	1/8	F4PB8-1/8	40
8	1/4	F4PB8-1/4	30
8	3/8	F4PB8-3/8	20
10	1/4	F4PB10-1/4	20
10	3/8	F4PB10-3/8	20
10	1/2	F4PB10-1/2	10
12	1/4	F4PB12-1/4	10
12	3/8	F4PB12-3/8	10
12	1/2	F4PB12-1/2	10
14	3/8	F4PB14-3/8	10
14	1/2	F4PB14-1/2	10

Parker Worldwide

AE – UAE, Dubai
Tel: +971 4 8127100
parker.me@parker.com

AR – Argentina, Buenos Aires
Tel: +54 3327 44 4129

AT – Austria, Wiener Neustadt
Tel: +43 (0)2622 23501-0
parker.austria@parker.com

AT – Eastern Europe,
Wiener Neustadt
Tel: +43 (0)2622 23501 900
parker.easteurope@parker.com

AU – Australia, Castle Hill
Tel: +61 (0)2-9634 7777

AZ – Azerbaijan, Baku
Tel: +994 50 2233 458
parker.azerbaijan@parker.com

BE/LU – Belgium, Nivelles
Tel: +32 (0)67 280 900
parker.belgium@parker.com

BR – Brazil, Cachoeirinha RS
Tel: +55 51 3470 9144

BY – Belarus, Minsk
Tel: +375 17 209 9399
parker.belarus@parker.com

CA – Canada, Milton, Ontario
Tel: +1 905 693 3000

CH – Switzerland, Etoy
Tel: +41 (0) 21 821 02 30
parker.switzerland@parker.com

CL – Chile, Santiago
Tel: +56 2 623 1216

CN – China, Shanghai
Tel: +86 21 5031 2525

CZ – Czech Republic, Klecany
Tel: +420 284 083 111
parker.czechrepublic@parker.com

DE – Germany, Kaarst
Tel: +49 (0)2131 4016 0
parker.germany@parker.com

DK – Denmark, Ballerup
Tel: +45 43 56 04 00
parker.denmark@parker.com

ES – Spain, Madrid
Tel: +34 902 33 00 01
parker.spain@parker.com

FI – Finland, Vantaa
Tel: +358 (0)20 753 2500
parker.finland@parker.com

FR – France, Contamine s/Arve
Tel: +33 (0)4 50 25 80 25
parker.france@parker.com

GR – Greece, Athens
Tel: +30 210 933 6450
parker.greece@parker.com

HK – Hong Kong
Tel: +852 2428 8008

HU – Hungary, Budapest
Tel: +36 1 220 4155
parker.hungary@parker.com

IE – Ireland, Dublin
Tel: +353 (0)1 466 6370
parker.ireland@parker.com

IN – India, Mumbai
Tel: +91 22 6513 7081-85

IT – Italy, Corsico (MI)
Tel: +39 02 45 19 21
parker.italy@parker.com

JP – Japan, Tokyo
Tel: +(81) 3 6408 3901

KR – South Korea, Seoul
Tel: +82 2 559 0400

KZ – Kazakhstan, Almaty
Tel: +7 7272 505 800
parker.easteurope@parker.com

LV – Latvia, Riga
Tel: +371 6 745 2601
parker.latvia@parker.com

MX – Mexico, Apodaca
Tel: +52 81 8156 6000

MY – Malaysia, Shah Alam
Tel: +60 3 7849 0800

NL – The Netherlands,
Oldenzaal
Tel: +31 (0)541 585 000
parker.nl@parker.com

NO – Norway, Ski
Tel: +47 64 91 10 00
parker.norway@parker.com

NZ – New Zealand, Mt Wellington
Tel: +64 9 574 1744

PL – Poland, Warsaw
Tel: +48 (0)22 573 24 00
parker.poland@parker.com

PT – Portugal, Leca da Palmeira
Tel: +351 22 999 7360
parker.portugal@parker.com

RO – Romania, Bucharest
Tel: +40 21 252 1382
parker.romania@parker.com

RU – Russia, Moscow
Tel: +7 495 645-2156
parker.russia@parker.com

SE – Sweden, Spånga
Tel: +46 (0)8 59 79 50 00
parker.sweden@parker.com

SG – Singapore
Tel: +65 6887 6300

SK – Slovakia, Banská Bystrica
Tel: +421 484 162 252
parker.slovakia@parker.com

SL – Slovenia, Novo Mesto
Tel: +386 7 337 6650
parker.slovenia@parker.com

TH – Thailand, Bangkok
Tel: +662 717 8140

TR – Turkey, Istanbul
Tel: +90 216 4997081
parker.turkey@parker.com

TW – Taiwan, Taipei
Tel: +886 2 2298 8987

UA – Ukraine, Kiev
Tel: +380 44 494 2731
parker.ukraine@parker.com

UK – United Kingdom,
Warwick
Tel: +44 (0)1926 317 878
parker.uk@parker.com

US – USA, Cleveland
Tel: +1 216 896 3000

VE – Venezuela, Caracas
Tel: +58 212 238 5422

ZA – South Africa,
Kempton Park
Tel: +27 (0)11 961 0700
parker.southafrica@parker.com

European Product Information Centre

Free phone: 00 800 27 27 5374

(from AT, BE, CH, CZ, DE, DK, ES, FI, FR, IE,
IT, NL, NO, PL, PT, RU, SE, UK, ZA)

