

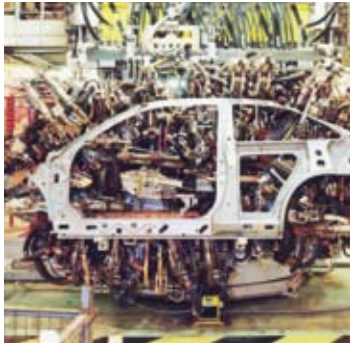

aerospace  
climate control  
electromechanical  
filtration  
fluid & gas handling  
hydraulics  
**pneumatics**  
process control  
sealing & shielding



# Directional Control Valves

Series VA13 and VA15

3- and 5-port valves. G1/8

Catalogue PDE2617TCUK. Edition June 09



ENGINEERING YOUR SUCCESS.

## Directional control valves

### Working medium, air quality

Working medium: Dry, filtered compressed air to ISO 8573-1 class 3.4.3.

### Recommended air quality

For best possible service life and trouble free operation, ISO 8573-1 quality class 3.4.3 should be used. This means 5µm filter (standard filter) dew point +3°C for indoor operation (a lower dew point should be selected for outdoor operation) and oil concentration 1.0 mg oil/m<sup>3</sup>, which is what a standard compressor with a standard filter gives.

### Compact installation dimensions - flexible installation



The VA13/15 valve range consists of spool valves of extremely robust design, incorporating a wide range of manual, mechanical and pilot-operated actuators.

### Rust and corrosion resistant designs.

The valve bodies and caps are made of brass. Stainless steel is used in the spools and the mechanical actuating devices. Versions intended for panel mounting have chromium-plated steel actuators and panel bezels.

### Mobile applications



The robust design, coupled with good corrosion resistance, makes the valves suitable for a wide range of applications. Manually operated valves are suitable for industrial and transport applications. The stable and ergonomically designed actuators make the valves easy to operate even with heavy working gloves.

### ISO 8573-1 quality classes

Quality class	Pollution		Water max. press. dew point (°C)	Oil max. concentration (mg/m <sup>3</sup> )
	particle size (µm)	max. concentration (mg/m <sup>3</sup> )		
1	0,1	0,1	-70	0,01
2	1	1	-40	0,1
3	5	5	-20	1,0
4	15	8	+3	5,0
5	40	10	+7	25
6	-	-	+10	-

### High reliability

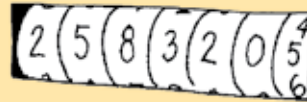

Valves easily comply with the requirements for component reliability in accordance with EU Machinery Directive standards EN292-2 and EN983.

The VA valves have few moving parts combined with short spool movement, these features combine to give valves having high reliability and long service life. The valves are designed for use with or without supplementary lubrication.

### Maintenance

When maintenance is required repair kits containing replacement seals are available. See page 15

**Directional control valves**

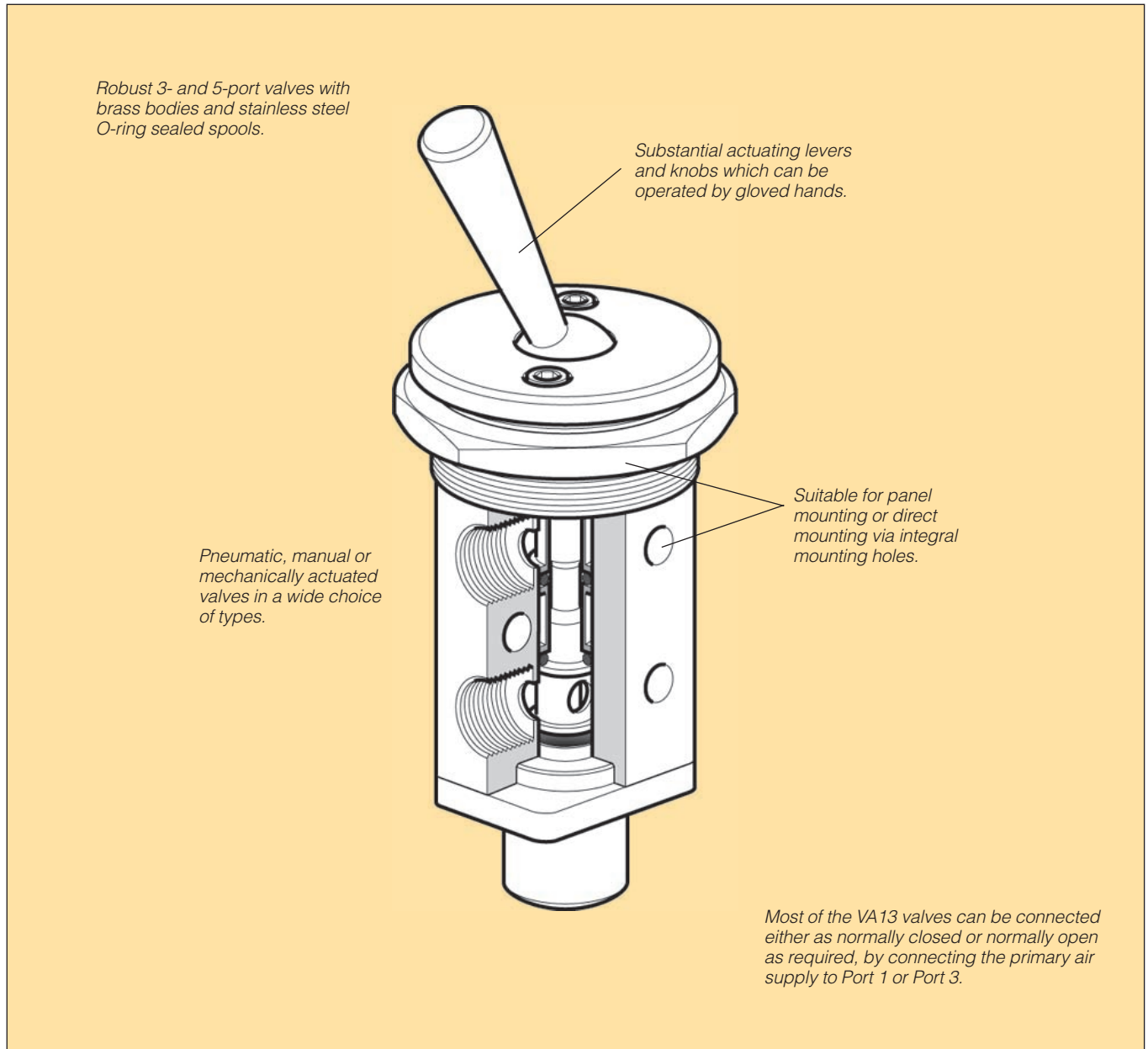

**Ordering example**

**VA13-HIS4**

Valve type, VA \_\_\_\_\_

Valve size 1 = G1/8 \_\_\_\_\_

Number of ports, 3 or 5 \_\_\_\_\_

Type of actuation \_\_\_\_\_

Type of return \_\_\_\_\_

Type of installation \_\_\_\_\_

4 = panel mounted \_\_\_\_\_

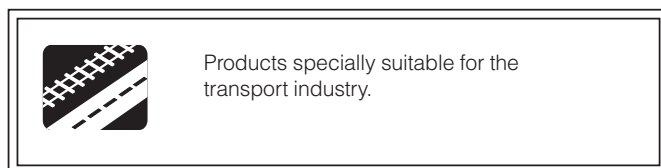

## Directional control valves

### Installation

Correctly mounted valves require only a minimum of maintenance. For maximum life, follow the instructions with regard to actuation directions, actuation speeds, angles and adjustments.

### Panel mounting

Mount the valves in a 40,5 mm diameter hole (thread M40 x 1,5). The panel-mounting collars have a flange on the front of the panel and a retaining nut behind the panel, for simple installation and clean and attractive appearance.

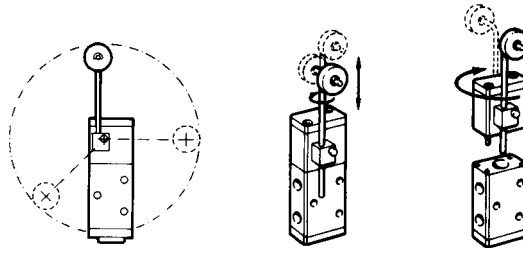

### Fitting adjustable roller actuators

The rest position of the actuating arm can be arranged at any required angle on the actuator shaft (360°).

The length of the arm is adjustable, and it can also be rotated through 180°. Note, however, that the roller must always be parallel to the valve body.

The arm can also be positioned on the other side of the valve by removing the actuating mechanism, turning it through 180° and reassembling it.

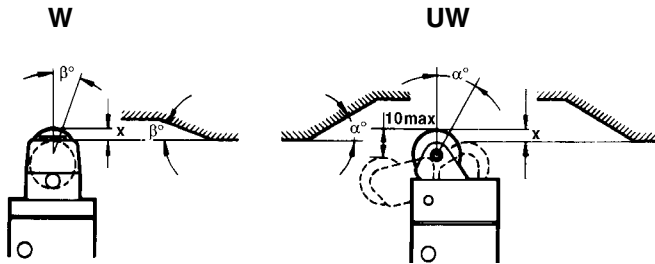

### Actuation

Maximum actuation distance (X), i.e. the maximum spool stroke length, is 4 mm. Valves are fully open after 3,5 mm travel. Type UW toggle cam actuators permit a vertical motion in toggle direction of up to 10 mm.

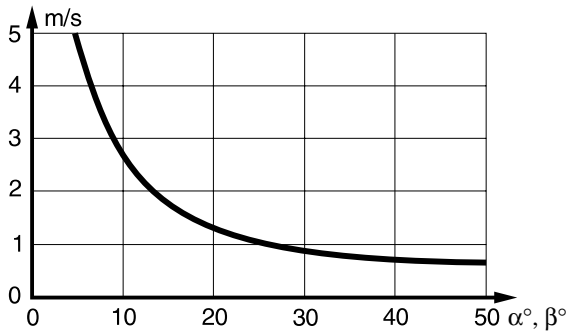

### Actuation speed as a function of actuation angle

Optimum valve life will be obtained if the shape of actuation cams is matched to the method of actuation employed. The principle is that the higher the speed of the actuating motion, the smaller the incident angle. The characteristic curve shown here plots the incident angle against speed of the actuating stroke.

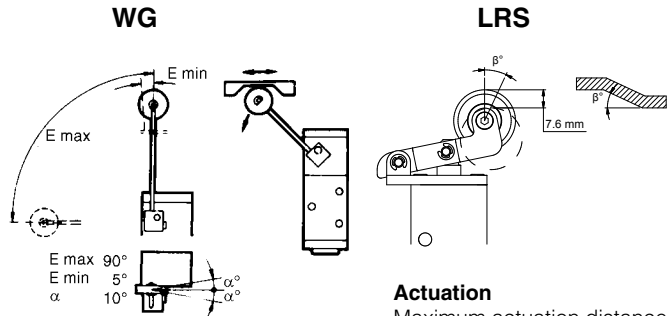

### Actuation

Maximum actuation distance, the maximum spool stroke length is 7.6 mm.

### Actuation by adjustable roller

Actuation can be arranged in both directions if the arm is set as shown above. The arm needs to be moved through only 5° to make the valve change over, although a travel range of up to 90° can be accepted.

### Material specifications

Valve bodies, end covers, spring guides	Brass
Spools	Polished stainless steel
Seals	Nitrile rubber
Screws, nuts, washers	Zinc plated steel
Balls	Steel
Push-buttons, knobs	Acetal plastic
Levers	Chrome-plated steel
Pedals	Phosphatized cast-iron
I-plunger	Hardened stainless steel
Rollers	Acetal plastic



### IMPORTANT

Before servicing, make sure that the valve is depressurised. Disconnect the primary air hose to ensure that the air supply is safely interrupted before removing valves.

**Data**

Working temperature:	-20 °C to +70 °C
Working pressure:	max 10 bar
Flow (acc. to ISO 6358)	
C:	0,9 NI/s, bar
Qn (P1=6 bar, Δp=1 bar):	3,6 l/s
Qmax:	6,3 l/s
Cv:	0,21

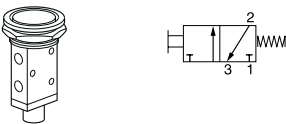
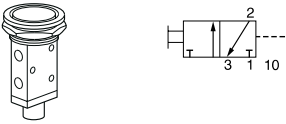
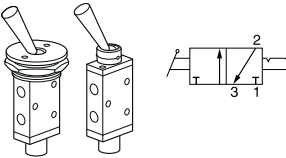
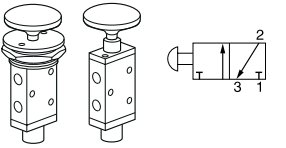
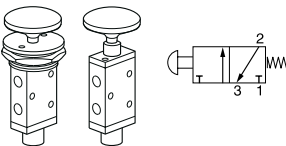
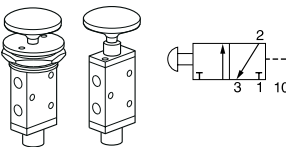
Symbol	Actuator	Return	Mounting	Changeover force at 6 bar	Weight kg	Order code
	Push-button Red	Spring	Panel mounted	32,5 N	0,37	<b>VA13-HIS4</b>
	Push-button Black	Spring	Panel mounted	32,5 N	0,37	<b>VA13-HIS4A06*</b>
	Push-button Red	Air signal	Panel mounted	6 N**	0,37	<b>VA13-HIA4</b>
	Hand lever Held in two positions	Hand lever	Panel mounted	8 N	0,52	<b>VA13-HB24</b>
		Hand lever	Side mounted	8 N	0,35	<b>VA13-HB2</b>
	Knob Red Two positions	Knob	Panel mounted	3 N	0,48	<b>VA13-KL24</b>
		Knob	Side mounted	3 N	0,31	<b>VA13-KL2</b>
	Knob Red	Spring	Panel mounted	31,5 N	0,49	<b>VA13-KS4</b>
		Spring	Side mounted	31,5 N	0,32	<b>VA13-KS</b>
	Knob Red Two positions	Knob/ Air signal	Panel mounted	6 N**	0,49	<b>VA13-KL2A4</b>
		Knob/ Air signal	Side mounted	6 N**	0,33	<b>VA13-KL2A</b>

\* Panel holder in black anodized aluminium.









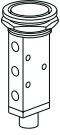
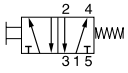
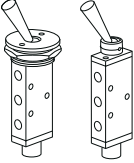
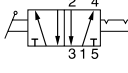

\*\* Without signal pressure. Signal pressure min 3 bar at 6 bar supply pressure.

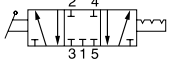
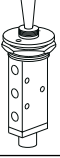
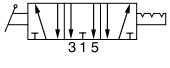
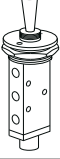
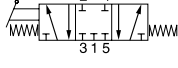

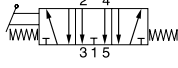
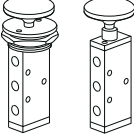
All VA13 valves (except VA13-WGR and VA13-RWG) can be connected either as normally closed 3/2 valve (NC) or normally open 3/2 valve (NO) as required, by connecting the primary air supply to Port 1 or Port 3.

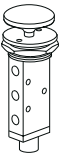
**Data**

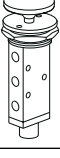
Working temperature: -20 °C to +70 °C  
 Working pressure: max 10 bar  
 Flow (acc. to ISO 6358)  
 C: 0,9 Nl/s, bar  
 Qn (P1=6 bar, Δp=1 bar): 3,6 l/s  
 Qmax: 6,3 l/s  
 Cv: 0,21

	Symbol	Actuator	Return	Mounting	Changeover force at 6 bar	Weight kg	Order code
		Push-button Red	Spring	Panel mounted	34,5 N	0,46	<b>VA15-HIS4</b>
		Hand lever Held in two positions	Hand lever	Panel mounted	9 N	0,63	<b>VA15-HB24</b>
				Side mounted	9 N	0,45	<b>VA15-HB2</b>
		Hand lever Held in three positions	Hand lever	Panel mounted Closed centre position	9 N	0,63	<b>VA15-HB34</b>
		Hand lever Held in three positions	Hand lever	Panel mounted Exhausted centre position	9 N	0,63	<b>VA15-XHB34</b>
		Hand lever Three positions self-centring	Hand lever	Panel mounted Closed centre position	9 N	0,63	<b>VA15-HC4</b>
		Hand lever Three positions self-centring	Hand lever	Panel mounted Exhausted centre position	9 N	0,63	<b>VA15-XHC4</b>
		Knob Red Two positions	Knob	Panel mounted	5 N	0,58	<b>VA15-KL24</b>
				Side mounted	5 N	0,42	<b>VA15-KL2</b>
		Knob Red	Spring	Panel mounted	34,5 N	0,60	<b>VA15-KS4</b>
		Knob Red Two positions	Knob/Air signal	Panel mounted	8 N*	0,61	<b>VA15-KL2A4</b>

\*Without signal pressure. Signal pressure min 3 bar at 6 bar supply pressure.

**Data**

Working temperature:	-20 °C to +70 °C
Working pressure:	max 10 bar
Flow (acc. to ISO 6358)	
C:	0,9 NI/s, bar
Qn (P1=6 bar, Δp=1 bar):	3,6 l/s
Qmax:	6,3 l/s
Cv:	0,21

**VA13**

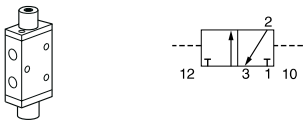
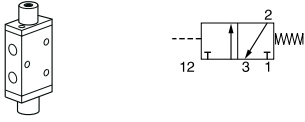
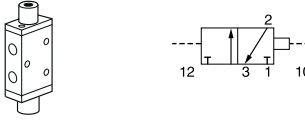
Symbol	Actuator	Return	Mounting	Signal pressure min, bar at 6 bar actu./return	Weight Kg	Order code
	Air signal	Air signal	Side mounted	3/3	0,33	<b>VA13-AA</b>
	Air signal	Spring	Side mounted	4/-	0,32	<b>VA13-AS</b>
	Air signal with priority	Air signal	Side mounted	3/4	0,32	<b>VA13-ADA</b>



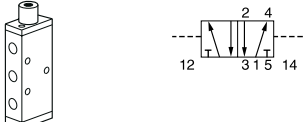
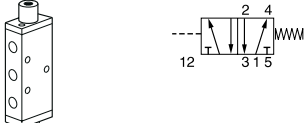
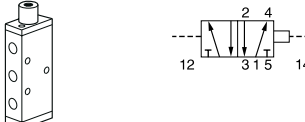



**VA15**

Symbol	Actuator	Return	Mounting	Signal pressure min, bar at 6 bar actu./return	Weight Kg	Order code
	Air signal	Air signal	Side mounted	3/3	0,33	<b>VA15-AA</b>
	Air signal	Spring	Side mounted	4/-	0,32	<b>VA15-AS</b>
	Air signal with priority	Air signal	Side mounted	3/4	0,32	<b>VA15-ADA</b>

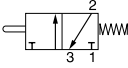

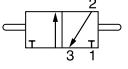
**Data**

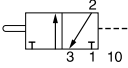
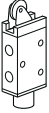
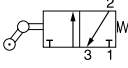
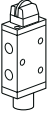
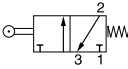
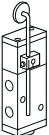
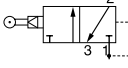
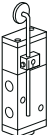
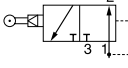
Working temperature: -20 °C to +70 °C  
 Working pressure: max 10 bar  
 max 8 bar for WGR and RWG  
 Flow (acc. to ISO 6358)  
 C: 0,9 NI/s, bar  
 Qn (P1=6 bar, Δp=1 bar): 3,6 l/s  
 Qmax: 6,3 l/s  
 Cv: 0,21

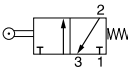
	Symbol	Actuator	Return	Mounting	Changeover force at 6 bar	Weight kg	Order code
		Plunger	Spring	Side mounted	32,5 N	0,30	<b>VA13-IS</b>
		Plunger Two positions	Plunger	Side mounted	3 N	0,30	<b>VA13-II</b>
		Plunger	Air signal	Side mounted	6 N*	0,30	<b>VA13-IA</b>
		Roller one way trip	Spring	Side mounted	20,5 N	0,33	<b>VA13-UWS</b>
		Roller	Spring	Side mounted	32,5 N	0,33	<b>VA13-WS</b>
		Roller on an arm	Internal air min 4 bar	Side mounted Normally closed	0,6 N min	0,41	<b>VA13-WGR</b>
		Roller on an arm	Internal air min 4 bar	Side mounted Normally open	0,6 N min	0,41	<b>VA13-RWG</b>
		Roller	Spring	Side mounted		0,41	<b>VA13-LRS</b>

\* Without signal pressure. Signal pressure min 3 bar at 6 bar supply pressure.





All VA13 valves (except VA13-WGR and VA13-RWG) can be connected either as normally closed 3/2 valve (NC) or normally open 3/2 valve (NO) as required, by connecting the primary air supply to Port 1 or Port 3.

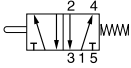

**Data**

Working temperature: -20 °C to +70 °C  
 Working pressure: max 10 bar  
 max 8 bar for WGR  
 Flow (acc. to ISO 6358)  
 C: 0,9 NI/s, bar  
 Qn (P1=6 bar, Δp=1 bar): 3,6 l/s  
 Qmax: 6,3 l/s  
 Cv: 0,21

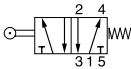
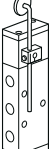
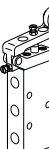
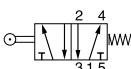
	Symbol	Actuator	Return	Mounting	Changeover force at 6 bar	Weight kg	Order code
		Plunger	Spring	Side mounted	34,5 N	0,40	<b>VA15-IS</b>
		Plunger Two positions	Plunger	Side mounted	5 N	0,40	<b>VA15-II</b>
		Roller one way trip	Spring	Side mounted	21,6 N	0,43	<b>VA15-UWS</b>
		Roller	Spring	Side mounted	34,5 N	0,44	<b>VA15-WS</b>
		Roller on an arm	Internal air min 4 bar	Side mounted	0,6 N min	0,46	<b>VA15-WGR</b>
		Roller	Spring	Side mounted		0,46	<b>VA15-LRS</b>

Dimensions

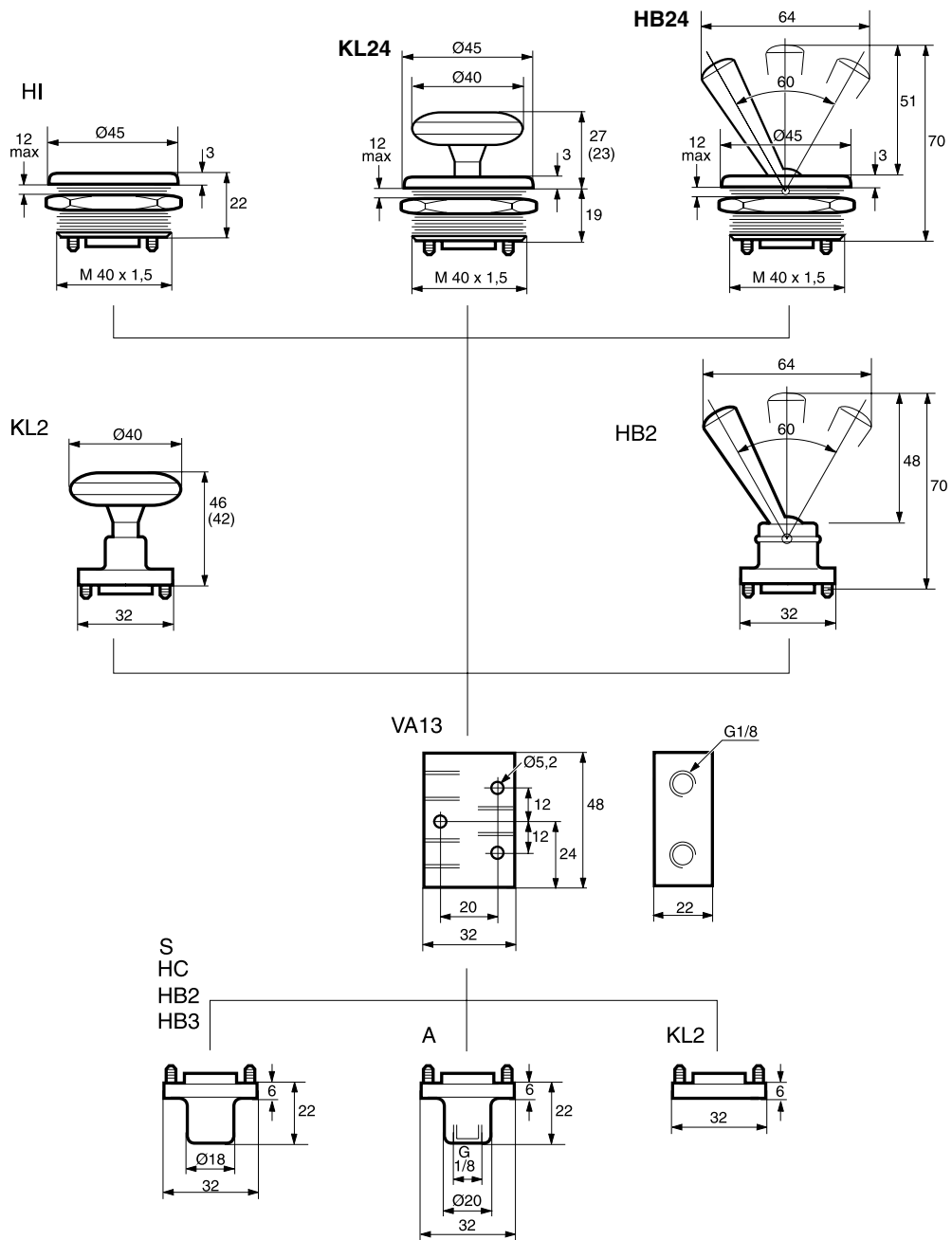

**Dimensions**

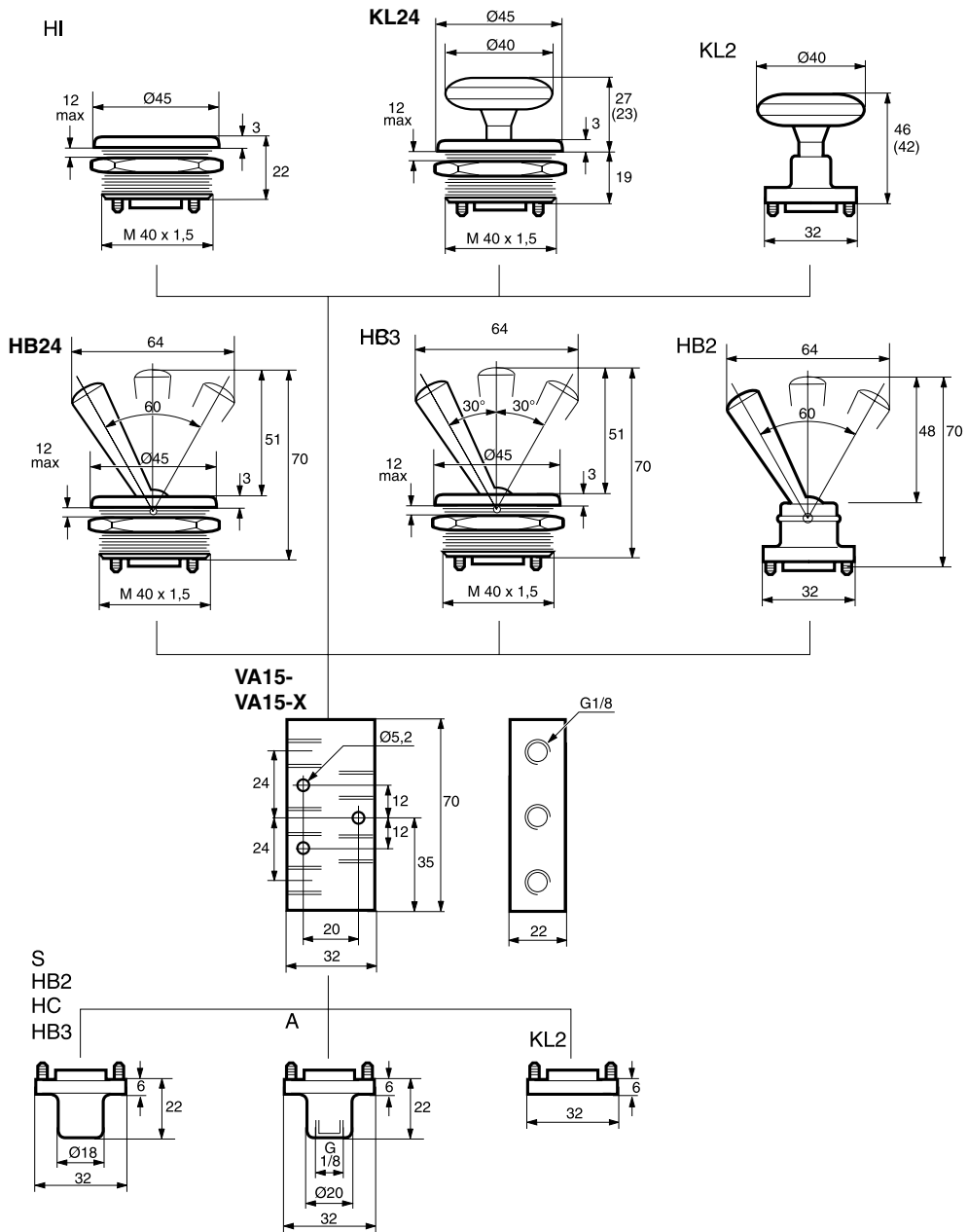

Dimensions

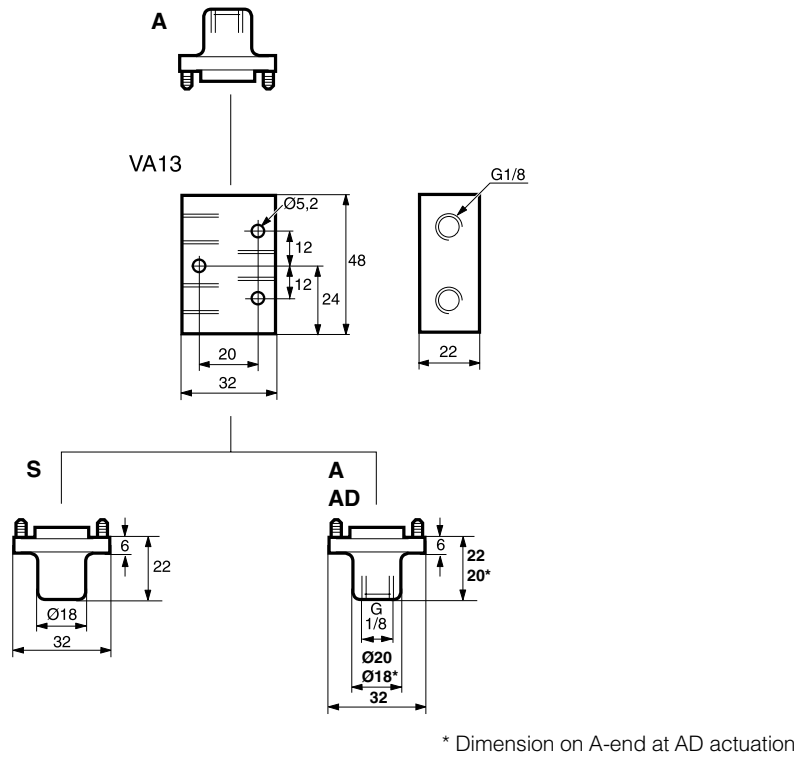

\* Dimension on A-end at AD actuation

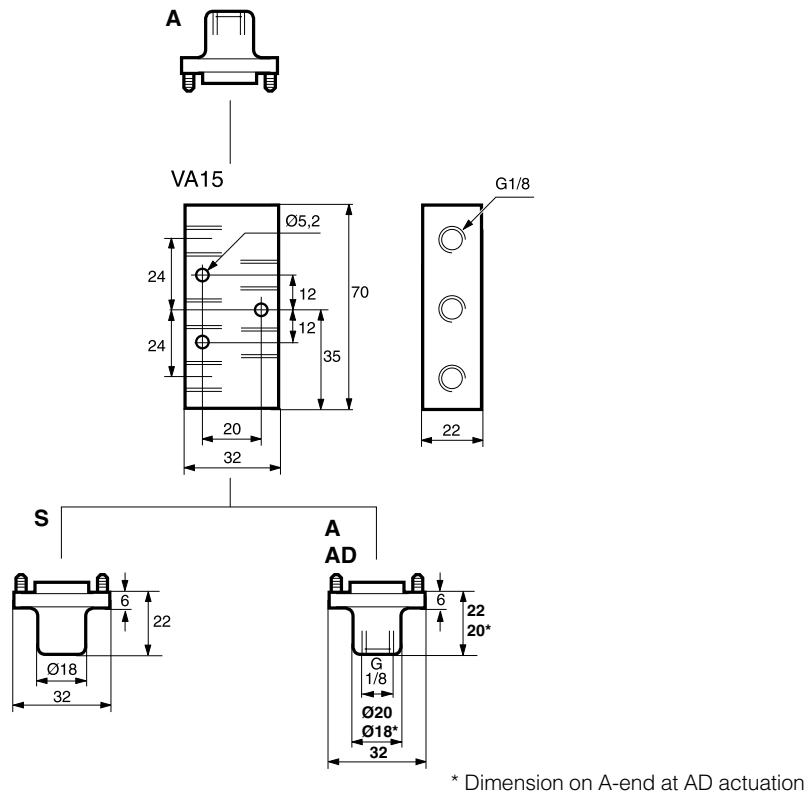

\* Dimension on A-end at AD actuation

Dimensions

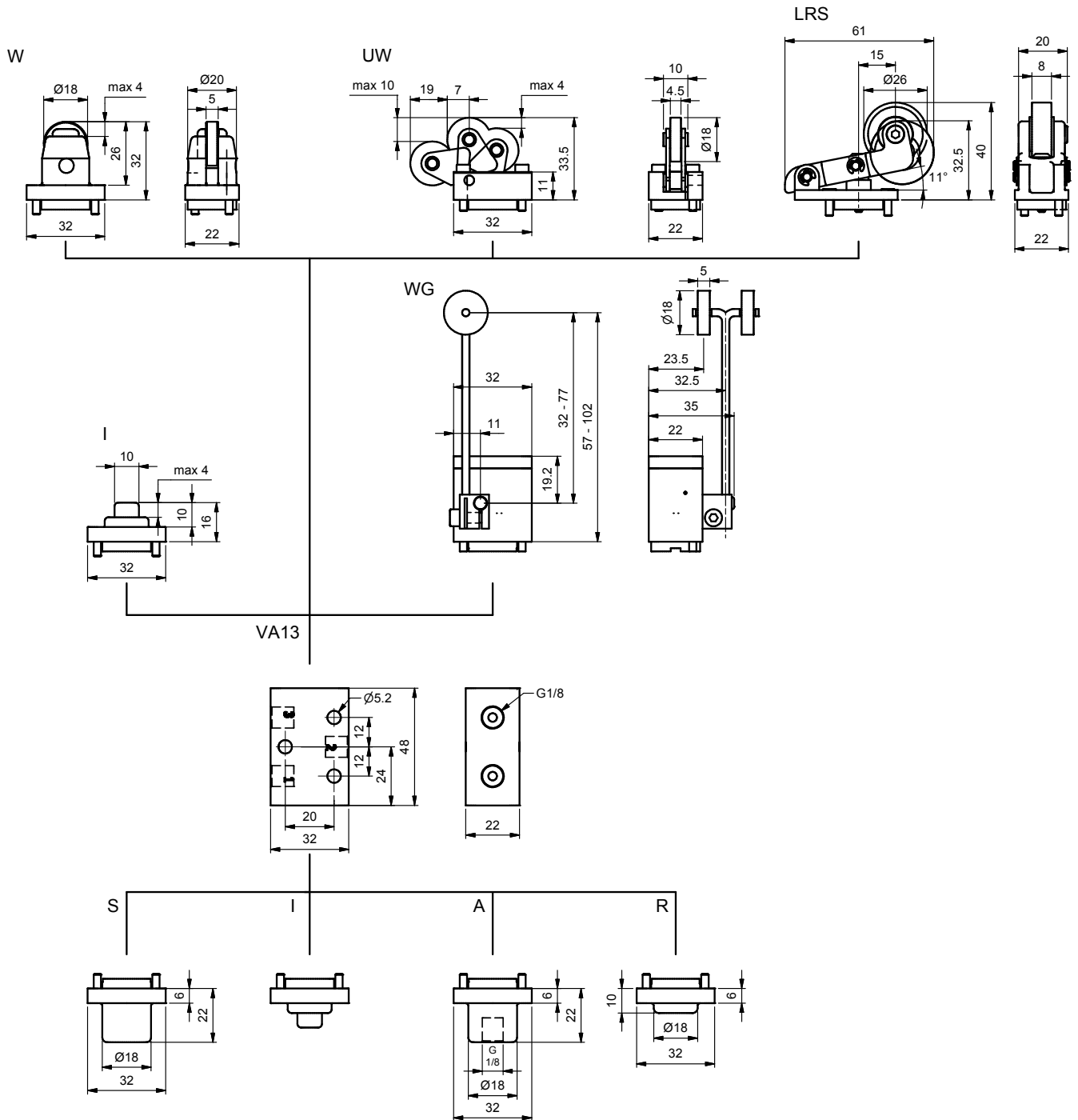

Dimensions

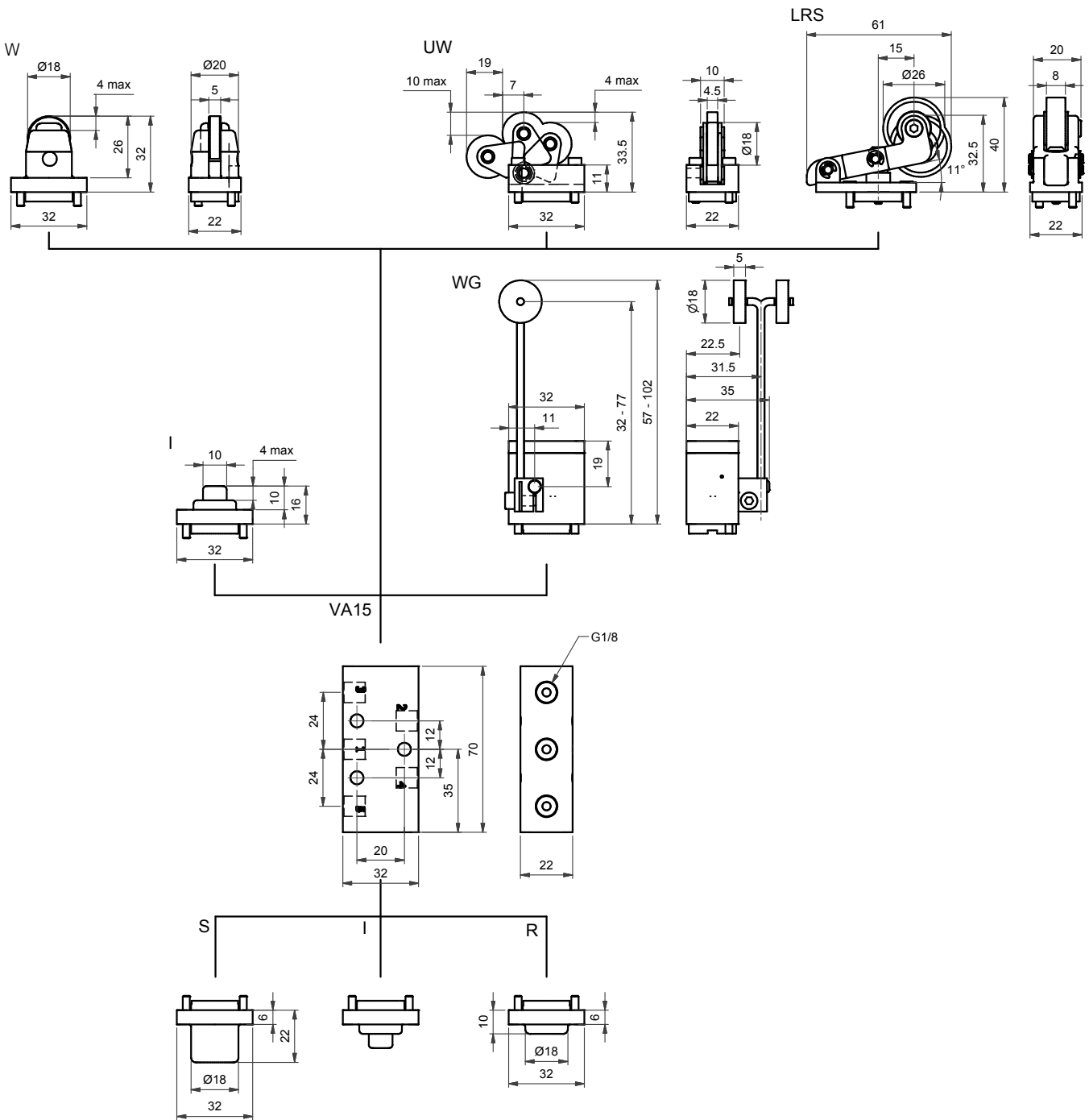

**Accessories**

**Sintered bronze series**

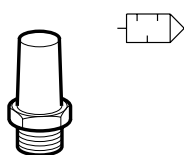

Port	Order code	Pack Qty
G1/8	<b>9090050700</b>	1

**Male straight connectors - Parallel thread**

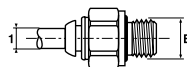

Tube Ø1	Thread B	Order code	Box Qty
4	1/8	<b>F4PMB4-1/8</b>	20
6	1/8	<b>F4PMB6-1/8</b>	30
8	1/8	<b>F4PB8-1/8</b>	40

**Service and Replacement Parts**

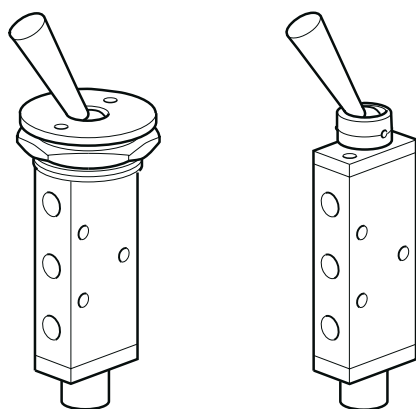

**VA Series Heavy Duty Valves**

Order code	Repair Kit
<b>9128674100</b>	Body seals (6 pcs. 'O' Ring)



**Important !**

Before carrying out any service work, ensure that the valve and manifold have been vented. Remove the primary supply air hose to ensure total disconnection of the air supply before dismantling valves or blank connection blocks.



**NB !**

All technical data in this catalogue is typical only. The air quality is decisive for the valve life: see ISO 8573.



**WARNING**

FAILURE OR IMPROPER SELECTION OR IMPROPER USE OF THE PRODUCTS AND/OR SYSTEMS DESCRIBED HEREIN OR RELATED ITEMS CAN CAUSE DEATH, PERSONAL INJURY AND PROPERTY DAMAGE.

This document and other information from Parker Hannifin Corporation, its subsidiaries and authorized distributors provide product and/or system options for further investigation by users having technical expertise. It is important that you analyze all aspects of your application and review the information concerning the product or system in the current product catalog. Due to the variety of operating conditions and applications for these products or systems, the user, through its own analysis and testing, is solely responsible for making the final selection of the products and systems and assuring that all performance, safety and warning requirements of the application are met. The products described herein, including without limitation, product features, specifications, designs, availability and pricing, are subject to change by Parker Hannifin Corporation and its subsidiaries at any time without notice.

**SALE CONDITIONS**

The items described in this document are available for sale by Parker Hannifin Corporation, its subsidiaries or its authorized distributors. Any sale contract entered into by Parker will be governed by the provisions stated in Parker's standard terms and conditions of sale (copy available upon request).



# Parker Worldwide

**AE – UAE, Dubai**  
Tel: +971 4 8127100  
parker.me@parker.com

**AR – Argentina, Buenos Aires**  
Tel: +54 3327 44 4129

**AT – Austria, Wiener Neustadt**  
Tel: +43 (0)2622 23501-0  
parker.austria@parker.com

**AT – Eastern Europe, Wiener Neustadt**  
Tel: +43 (0)2622 23501 900  
parker.easteurope@parker.com

**AU – Australia, Castle Hill**  
Tel: +61 (0)2-9634 7777

**AZ – Azerbaijan, Baku**  
Tel: +994 50 2233 458  
parker.azerbaijan@parker.com

**BE/LU – Belgium, Nivelles**  
Tel: +32 (0)67 280 900  
parker.belgium@parker.com

**BR – Brazil, Cachoeirinha RS**  
Tel: +55 51 3470 9144

**BY – Belarus, Minsk**  
Tel: +375 17 209 9399  
parker.belarus@parker.com

**CA – Canada, Milton, Ontario**  
Tel: +1 905 693 3000

**CH – Switzerland, Etoy**  
Tel: +41 (0) 21 821 02 30  
parker.switzerland@parker.com

**CL – Chile, Santiago**  
Tel: +56 2 623 1216

**CN – China, Shanghai**  
Tel: +86 21 5031 2525

**CZ – Czech Republic, Klecany**  
Tel: +420 284 083 111  
parker.czechrepublic@parker.com

**DE – Germany, Kaarst**  
Tel: +49 (0)2131 4016 0  
parker.germany@parker.com

**DK – Denmark, Ballerup**  
Tel: +45 43 56 04 00  
parker.denmark@parker.com

**ES – Spain, Madrid**  
Tel: +34 902 33 00 01  
parker.spain@parker.com

**FI – Finland, Vantaa**  
Tel: +358 (0)20 753 2500  
parker.finland@parker.com

**FR – France, Contamine s/Arve**  
Tel: +33 (0)4 50 25 80 25  
parker.france@parker.com

**GR – Greece, Athens**  
Tel: +30 210 933 6450  
parker.greece@parker.com

**HK – Hong Kong**  
Tel: +852 2428 8008

**HU – Hungary, Budapest**  
Tel: +36 1 220 4155  
parker.hungary@parker.com

**IE – Ireland, Dublin**  
Tel: +353 (0)1 466 6370  
parker.ireland@parker.com

**IN – India, Mumbai**  
Tel: +91 22 6513 7081-85

**IT – Italy, Corsico (MI)**  
Tel: +39 02 45 19 21  
parker.italy@parker.com

**JP – Japan, Tokyo**  
Tel: +(81) 3 6408 3901

**KR – South Korea, Seoul**  
Tel: +82 2 559 0400

**KZ – Kazakhstan, Almaty**  
Tel: +7 7272 505 800  
parker.easteurope@parker.com

**LV – Latvia, Riga**  
Tel: +371 6 745 2601  
parker.latvia@parker.com

**MX – Mexico, Apodaca**  
Tel: +52 81 8156 6000

**MY – Malaysia, Shah Alam**  
Tel: +60 3 7849 0800

**NL – The Netherlands, Oldenzaal**  
Tel: +31 (0)541 585 000  
parker.nl@parker.com

**NO – Norway, Ski**  
Tel: +47 64 91 10 00  
parker.norway@parker.com

**NZ – New Zealand, Mt Wellington**  
Tel: +64 9 574 1744

**PL – Poland, Warsaw**  
Tel: +48 (0)22 573 24 00  
parker.poland@parker.com

**PT – Portugal, Leca da Palmeira**  
Tel: +351 22 999 7360  
parker.portugal@parker.com

**RO – Romania, Bucharest**  
Tel: +40 21 252 1382  
parker.romania@parker.com

**RU – Russia, Moscow**  
Tel: +7 495 645-2156  
parker.russia@parker.com

**SE – Sweden, Spånga**  
Tel: +46 (0)8 59 79 50 00  
parker.sweden@parker.com

**SG – Singapore**  
Tel: +65 6887 6300

**SK – Slovakia, Banská Bystrica**  
Tel: +421 484 162 252  
parker.slovakia@parker.com

**SL – Slovenia, Novo Mesto**  
Tel: +386 7 337 6650  
parker.slovenia@parker.com

**TH – Thailand, Bangkok**  
Tel: +662 717 8140

**TR – Turkey, Istanbul**  
Tel: +90 216 4997081  
parker.turkey@parker.com

**TW – Taiwan, Taipei**  
Tel: +886 2 2298 8987

**UA – Ukraine, Kiev**  
Tel: +380 44 494 2731  
parker.ukraine@parker.com

**UK – United Kingdom, Warwick**  
Tel: +44 (0)1926 317 878  
parker.uk@parker.com

**US – USA, Cleveland**  
Tel: +1 216 896 3000

**VE – Venezuela, Caracas**  
Tel: +58 212 238 5422

**ZA – South Africa, Kempton Park**  
Tel: +27 (0)11 961 0700  
parker.southafrica@parker.com

European Product Information Centre

Free phone: 00 800 27 27 5374

(from AT, BE, CH, CZ, DE, DK, ES, FI, FR, IE, IT, NL, NO, PL, PT, RU, SE, UK, ZA)



## Parker Hannifin Ltd

Pneumatic Division Europe  
The Collins Centre,  
Lichfield South, Wall Island,  
Birmingham Road, Lichfield.  
WS14 0QP United Kingdom  
Tel.: +44 (0) 1543 483800  
Fax: +44 (0) 1543 483801  
www.parker.com/euro\_pneumatic