



aerospace  
climate control  
electromechanical  
filtration  
fluid & gas handling  
hydraulics  
**pneumatics**  
process control  
sealing & shielding



# Pneumatic cylinders

Profile cylinders series P1K

Catalogue PDE2577TCUK-ul. November 2009



ENGINEERING YOUR SUCCESS.

Features	Air cylinder	Hydraulic cylinder	Electro mechanical actuators
Overload safe	***	***	*
Easy to limit force	***	***	*
Easy to vary speed	***	***	*
Speed	***	**	**
Reliability	***	***	***
Robustness	***	***	*
Installation cost	***	*	**
Ease of service	***	**	*
Safety in damp environments	***	***	*
Safety in explosive atmospheres	***	***	*
Safety risk with electrical installations	***	***	*
Risk of oil leak	***	*	***
Clean, hygienic	***	**	*
Standardised measurements	***	***	*
Service life	***	***	*
Hydraulic system required	***	*	***
Weight	**	**	**
Purchase price	***	**	*
Power density	**	***	*
Noise level during operation	**	***	**
High force for size	**	***	*
Positioning possibilities	*	***	***
Total energy consumption	*	**	***
Service interval	*	**	***
Compressor capacity required	*	***	***

\* = good, \*\*=average, \*\*\*=excellent



**Important**  
 Before attempting any external or internal work on the cylinder or any connected components, make sure the cylinder is vented and disconnect the air supply in order to ensure isolation of the air supply.



**Note**  
 All technical data in this catalogue are typical data only.  
 Air quality is essential for maximum cylinder service life (see ISO 8573).



**WARNING**

**FAILURE OR IMPROPER SELECTION OR IMPROPER USE OF THE PRODUCTS AND/OR SYSTEMS DESCRIBED HEREIN OR RELATED ITEMS CAN CAUSE DEATH, PERSONAL INJURY AND PROPERTY DAMAGE.**

This document and other information from Parker Hannifin Corporation, its subsidiaries and authorized distributors provide product and/or system options for further investigation by users having technical expertise. It is important that you analyze all aspects of your application and review the information concerning the product or system in the current product catalog. Due to the variety of operating conditions and applications for these products or systems, the user, through its own analysis and testing, is solely responsible for making the final selection of the products and systems and assuring that all performance, safety and warning requirements of the application are met. The products described herein, including without limitation, product features, specifications, designs, availability and pricing, are subject to change by Parker Hannifin Corporation and its subsidiaries at any time without notice.

**SALE CONDITIONS**

The items described in this document are available for sale by Parker Hannifin Corporation, its subsidiaries or its authorized distributors. Any sale contract entered into by Parker will be governed by the provisions stated in Parker's standard terms and conditions of sale (copy available upon request).

<b>Contents</b>	<b>Page</b>
P1K profile cylinders.....	4
Cylinder forces .....	6
Operation data .....	6
Working medium, air quality .....	6
Main data.....	7
Material specifications.....	7
Guide for selecting suitable tubing .....	8
Order key.....	10
Standard stroke length in mm .....	10
Order code standard stroke double-acting.....	11
Order code standard stroke single-acting, spring return.....	11
Order key, special versions .....	12
Dimensions.....	13
Mountings.....	14-18
Tightening torques .....	19
Seal kits for complete P1K cylinder.....	19
Grease for P1K.....	19

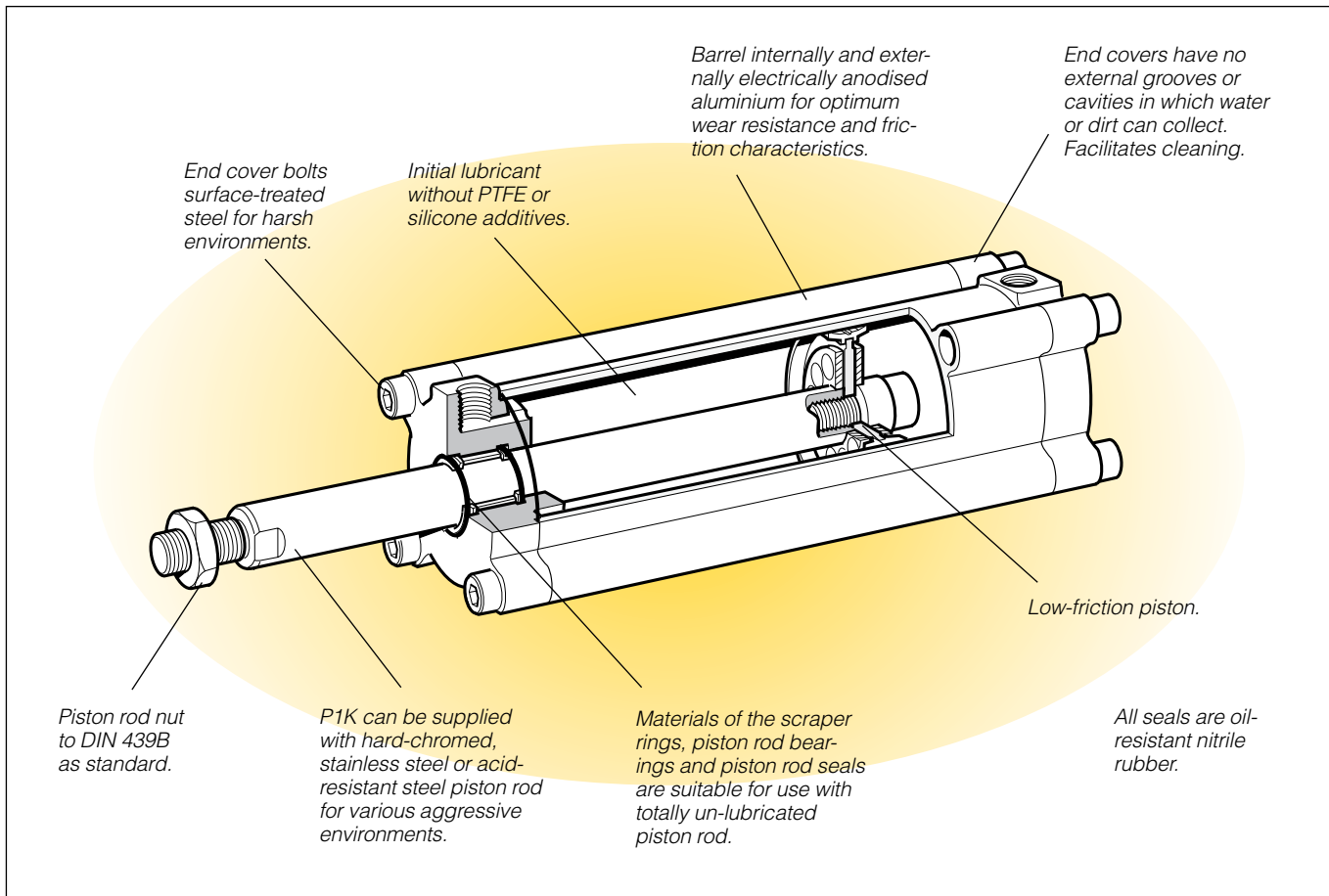

## P1K profile cylinders

The Parker P1K series cylinders are double acting with fixed end cushioning for light duty applications. The range is based upon the international ISO 6431 standard, but with considerably shorter overall length. They are available in bore sizes 32-125 mm with standard stroke lengths, 25-320 mm.

A complete range of mountings is available to suit the numerous application requirements, however, if required, the cylinders can be directly mounted using the existing end cover bolts.

The end plates and aluminium tube have the same profile, eliminating pockets or grooves where dirt could collect, the smooth clean surfaces meet strict hygienic requirements.

P1K cylinders are pre-lubricated during assembly and under normal operating conditions require no further lubrication. To ensure long life, particularly in applications where initial piston rod lubrication may be washed off, for example with detergents, the rod wiper and neck seal are manufactured from lubricant impregnated polythene.

The cylinder is available as a single-acting spring return version with strokes of 25 or 50 mm depending upon bore size.

A range of special cylinders to suit various applications can be produced from the basic P1K unit.

## Clean design for foodstuffs applications

The clean design with end plates that precisely line up with the unique housing tube profile means that a lot of P1K cylinders are used in the foodstuffs industry. With a few adaptations, such as fully anodised end plate screws, the P1K is the perfect cylinder for cheesemaking equipment.

The fully anodised cylinders, with their hygienic, easily cleaned design, are installed vertically and press the whey out of the curds. This is an example of where the P1K offers decisive advantages for applications where hygiene and cleanliness are important requirements.

**Cushioning**

The P1K range of cylinders incorporate fixed end cushioning suitable for lighter duty applications. If used for high loads, provision should be made for external stops and damping. The high and low temperature versions are not available with cushioning.

**Clean external design**

The end plates of P1K cylinders have no recesses or cavities; this prevents retention of dirt or liquids and enables simple and effective cleaning.

**Corrosion resistance**

The selection of materials and surface treatments ensure that even standard versions of the P1K cylinder have good corrosion resistance and make them suitable for applications in demanding environments.

**Dry Operation**

The design of the cylinder makes it ideal for applications demanding hygiene and regular cleaning. Use of pre-lubricated materials together with the design of piston rod bearing, scraper and seal enable regular wiping/de-greasing of the piston rod without jeopardising the service life.

**Mountings**

A complete range of corrosion resistant mountings is available.

**Options**

In addition to the standard version, the P1K cylinder is available with various options depending upon the basic model selected.

- Non standard stroke lengths
- Choice of piston rod materials
- Extended piston rods
- Through piston rod
- End cap screws in stainless steel
- Single acting

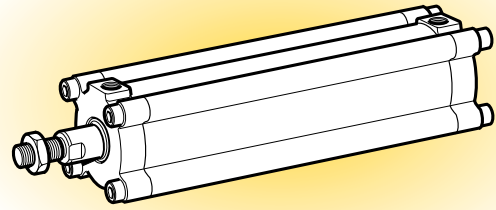

Double acting

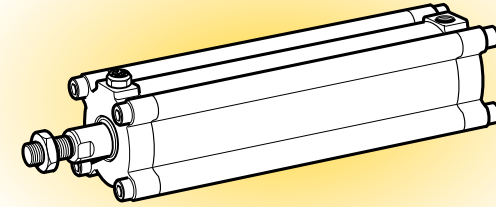

Single acting

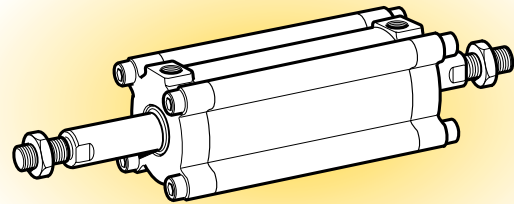

Double acting with through piston rods

**Cylinder forces, double acting variants**

Cyl. bore/ pist. rod mm	Stroke	Pistonarea cm <sup>2</sup>	Max theoretical force in N (bar)									
			1,0	2,0	3,0	4,0	5,0	6,0	7,0	8,0	9,0	10,0
<b>32/12</b>	+	8,0	80	161	241	322	402	<b>483</b>	563	643	724	804
	-	6,9	69	138	207	276	346	<b>415</b>	484	553	622	691
<b>40/16</b>	+	12,6	126	251	377	503	628	<b>754</b>	880	1005	1131	1257
	-	10,6	106	212	318	424	530	<b>636</b>	742	848	954	1060
<b>50/20</b>	+	19,6	196	393	589	785	982	<b>1178</b>	1374	1571	1767	1963
	-	16,5	165	330	495	660	825	<b>990</b>	1155	1319	1484	1649
<b>63/20</b>	+	31,2	312	623	935	1247	1559	<b>1870</b>	2182	2494	2806	3117
	-	28,0	280	561	841	1121	1402	<b>1682</b>	1962	2242	2523	2803
<b>80/25</b>	+	50,3	503	1005	1508	2011	2513	<b>3016</b>	3519	4021	4524	5027
	-	45,4	454	907	1361	1814	2268	<b>2721</b>	3175	3629	4082	4536
<b>100/32</b>	+	78,5	785	1571	2356	3142	3927	<b>4712</b>	5498	6283	7069	7854
	-	70,5	705	1410	2115	2820	3525	<b>4230</b>	4935	5640	6345	7050
<b>125/32</b>	+	122,7	1227	2454	3682	4909	6136	<b>7363</b>	8590	9817	11045	12272
	-	114,7	1147	2294	3440	4587	5734	<b>6881</b>	8027	9174	10321	11468

+ = Outward stroke  
- = Return stroke

**Note!**  
Select a theoretical force 50-100% larger than the force required

**Operation data**

Working pressure	Max 10 bar	
Working temperature	min	max
Standard	-20 °C	+80 °C
High temp version	-10 °C	+150 °C
Low temp version	-40 °C	+40 °C

Greased for life, does not normally need additional lubrication. If extra lubrication is given, this must always be continued.

**Working medium, air quality**

Working medium Dry, filtered compressed air to ISO 8573-1 class 3.4.3.

**Recommended air quality for cylinders**

For best possible service life and trouble-free operation, ISO 8573-1 quality class 3.4.3 should be used. This means 5 µm filter (standard filter) dew point +3 °C for indoor operation (a lower dew point should be selected for outdoor operation) and oil concentration 1.0 mg oil/m<sup>3</sup>, which is what a standard compressor with a standard filter gives.

**ISO 8573-1 quality classes**

Quality class	Pollution		Water	Oil
	particle size (µm)	max concentration (mg/m <sup>3</sup> )	max. press. dew point (°C)	max concentration (mg/m <sup>3</sup> )
<b>1</b>	0,1	0,1	-70	0,01
<b>2</b>	1	1	-40	0,1
<b>3</b>	5	5	-20	1,0
<b>4</b>	15	8	+3	5,0
<b>5</b>	40	10	+7	25
<b>6</b>	-	-	+10	-



**Important!**

When the cylinders are used in applications with heavy side loading on the piston rod, an outer guide must be used to ensure maximum service life.

## Main data

Cylinder designation	Cylinder bore		Piston rod area		Piston rod diam. thread	Total mass at 0 mm stroke length kg	Mass, moving parts		Air consumption litre	Port size G	
	mm	cm <sup>2</sup>	mm	cm <sup>2</sup>			Addition per 10 mm stroke kg	at 0 mm stroke length kg			Addition per 10 mm stroke kg
<b>Double acting</b>											
P1K-S032DT-XXXX <sup>1)</sup>	32	8,0	12	1,1	M10x1,25	0,33	0,024	0,09	0,009	0,105 <sup>2)</sup>	1/8
P1K-S040DT-XXXX <sup>1)</sup>	40	12,6	16	2,0	M12x1,25	0,48	0,032	0,14	0,016	0,162 <sup>2)</sup>	1/8
P1K-S050DT-XXXX <sup>1)</sup>	50	19,6	20	3,1	M16x1,5	0,70	0,049	0,26	0,025	0,253 <sup>2)</sup>	1/8
P1K-S063DT-XXXX <sup>1)</sup>	63	31,2	20	3,1	M16x1,5	1,04	0,058	0,31	0,025	0,414 <sup>2)</sup>	1/8
P1K-S080DT-XXXX <sup>1)</sup>	80	50,0	25	4,9	M20x1,5	1,75	0,081	0,56	0,039	0,669 <sup>2)</sup>	1/4
P1K-S100DT-XXXX <sup>1)</sup>	100	79,0	32	8,0	M20x1,5	2,48	0,116	0,86	0,063	1,043 <sup>2)</sup>	1/4
P1K-S125DT-XXXX <sup>1)</sup>	125	123,0	32	8,0	M27x2	4,35	0,138	1,77	0,063	1,662 <sup>2)</sup>	3/8
<b>Single acting</b>											
P1K-S032ST-0025	32	8,0	12	1,1	M10x1,25	0,48 <sup>3)</sup>		0,15 <sup>3)</sup>		0,141 <sup>3)</sup>	1/8
P1K-S032ST-0050	32	8,0	12	1,1	M10x1,25	0,60 <sup>3)</sup>		0,27 <sup>3)</sup>		0,282 <sup>3)</sup>	1/8
P1K-S040ST-0025	40	12,6	16	2,0	M12x1,25	0,67 <sup>3)</sup>		0,24 <sup>3)</sup>		0,220 <sup>3)</sup>	1/8
P1K-S040ST-0050	40	12,6	16	2,0	M12x1,25	0,84 <sup>3)</sup>		0,32 <sup>3)</sup>		0,440 <sup>3)</sup>	1/8
P1K-S050ST-0025	50	19,6	20	3,1	M16x1,5	1,02 <sup>3)</sup>		0,44 <sup>3)</sup>		0,344 <sup>3)</sup>	1/8
P1K-S050ST-0050	50	19,6	20	3,1	M16x1,5	1,27 <sup>3)</sup>		0,57 <sup>3)</sup>		0,688 <sup>3)</sup>	1/8
P1K-S063ST-0025	63	31,2	20	3,1	M16x1,5	1,41 <sup>3)</sup>		0,51 <sup>3)</sup>		0,546 <sup>3)</sup>	1/8
P1K-S063ST-0050	63	31,2	20	3,1	M16x1,5	1,72 <sup>3)</sup>		0,63 <sup>3)</sup>		1,092 <sup>3)</sup>	1/8
P1K-S080ST-0050	80	50,0	25	4,9	M20x1,5	2,81 <sup>3)</sup>		1,13 <sup>3)</sup>		1,760 <sup>3)</sup>	1/4
P1K-S100ST-0050	100	79,0	32	8,0	M20x1,5	3,99 <sup>3)</sup>		1,74 <sup>3)</sup>		2,748 <sup>3)</sup>	1/4

1) XXXX=stroke length. 2) Free air consumption per 100 mm stroke length for a double stroke at 6 bar. 3) At the relevant stroke length.

## Piston forces

The values for piston forces are theoretical and should be reduced to suit working conditions.

Cylinder designation	Theoretical piston force at 6 bar		Spring force	
	Plus stroke Nmin	Nmax	Minus stroke Nmin	Nmax
<b>Single acting</b>				
P1K-S032ST-0025	450	441	39	30
P1K-S032ST-0050	450	432	48	30
P1K-S040ST-0025	714	704	50	40
P1K-S040ST-0050	714	688	50	40
P1K-S050ST-0025	1120	1101	79	60
P1K-S050ST-0050	1120	1090	90	60
P1K-S063ST-0025	1800	1782	88	70
P1K-S063ST-0050	1800	1771	99	70
P1K-S080ST-0050	2925	2878	142	95
P1K-S100ST-0050	4570	4518	192	140

## Material specifications

Cylinder barrel	Anodised aluminium
End covers	Anodised aluminium
End cap screws	Galvanized steel
Piston	Steel/Nitrile rubber, NBR
Piston rod bearing	Acetal plastic/Bronze/Steel
Piston rod	Hard chromium plated steel
	Fe 490-2 FN
Scraper ring, piston rod sealing	UHMWPE-plastic
Cushioning ring	Polyurethane
Other sealings	Nitrile rubber, NBR
Return spring	stainless spring steel

## Option

Piston rod material	Hard-chromium plated steel, Fe 490-2 FN
	Acid-proof steel, X 5 CrNiMo 17 13 3
	Hard-chromium plated stainless steel, X 10 CrNiS 18 9

**Guide for selecting suitable tubing**

The selection of the correct size of tubing is often based on experience, with no great thought to optimizing energy efficiency and cylinder velocity. This is usually acceptable, but making a rough calculation can result in worthwhile economic gains.

**The following is the basic principle:**

1. The primary line to the working valve could be over sized (this does not cause any extra air consumption and consequently does not create any extra costs in operation).
2. The tubes between the valve and the cylinder should, however, be optimized according to the principle that an insufficient bore throttles the flow and thus limits the cylinder speed, while an oversized pipe creates a dead volume which increases the air consumption and filling time.

The chart below is intended to help when selecting the correct size of tube to use between the valve and the cylinder.

**The following prerequisites apply:**

The cylinder load should be about 50% of the theoretical force (= normal load). A lower load gives a higher velocity and vice versa. The tube size is selected as a function of the cylinder bore, the desired cylinder velocity and the tube length between the valve and the cylinder.

If you want to use the capacity of the valve to its maximum, and obtain maximum speed, the tubing should be chosen so that they at least correspond with the equivalent restriction diameter (see description below), so that the tubing does not restrict the total flow. This means that a short tubing must have at least the equivalent restriction diameter. If the tubing is longer, choose it from the table below. Straight fittings should be chosen for highest flow rates. (Elbow and banjo fittings cause restriction.)

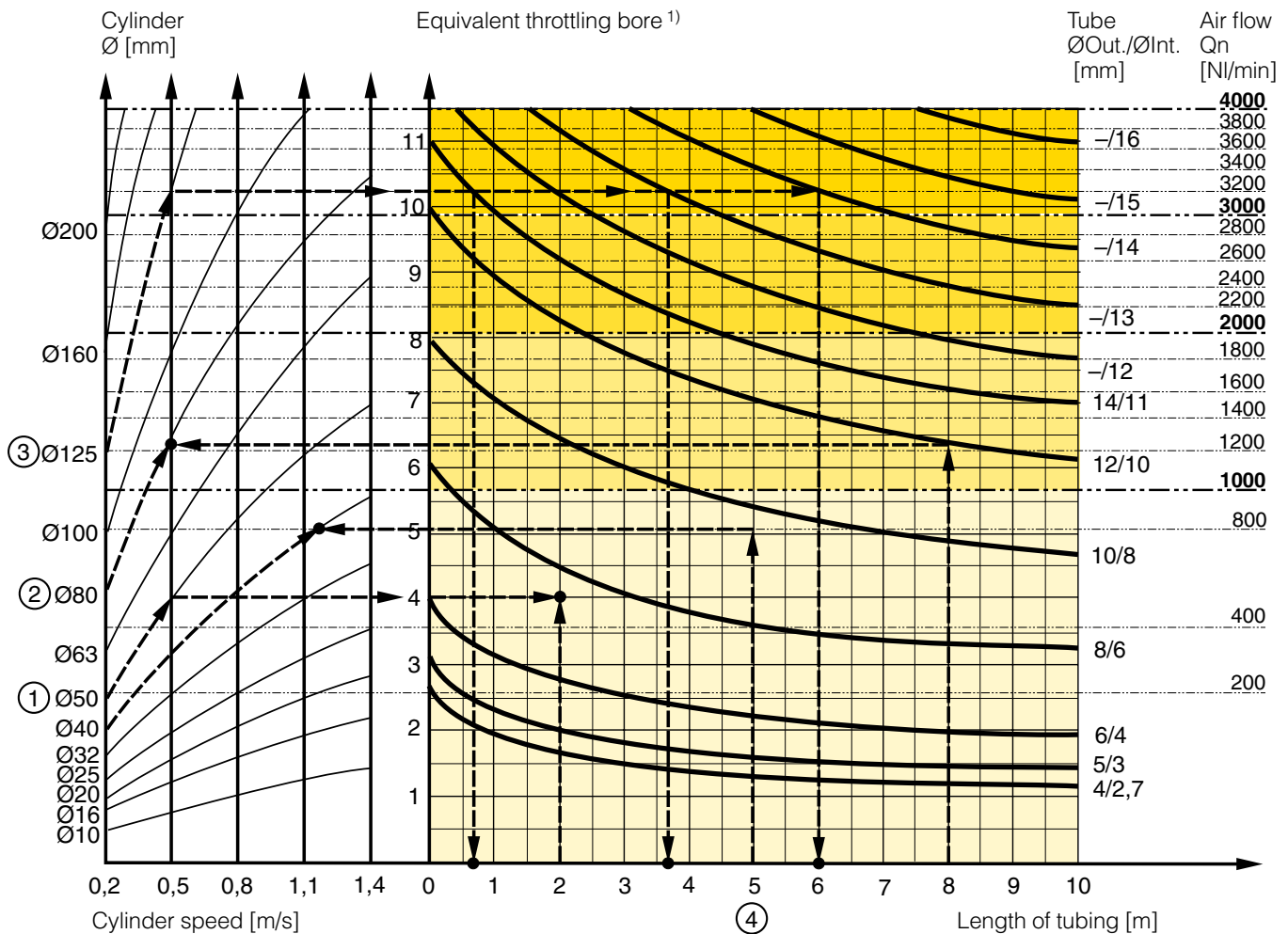

- 1) The "equivalent throttling bore" is a long throttle (for example a tube) or a series of throttles (for example, through a valve) converted to a short throttle which gives a corresponding flow rate. This should not be confused with the "orifice" which is sometimes specified for valves. The value for the orifice does not normally take account of the fact that the valve contains a number of throttles.
- 2) Qn is a measure of the valve flow capacity, with flow measured in litre per minute (l/min) at 6 bar(e) supply pressure and 1 bar pressure drop across the valve.



### Example ①: Which tube diameter should be used?

A 50 mm bore cylinder is to be operated at 0.5 m/s. The tube length between the valve and cylinder is 2 m. In the diagram we follow the line from 50 mm bore to 0.5 m/s and get an "equivalent throttling bore" of approximately 4 mm. We continue out to the right in the chart and intersect the line for a 2 m tube between the curves for 4 mm (6/4 tube) and 6 mm (8/6 tube). This means that a 6/4 tube throttles the velocity somewhat, while an 8/6 tube is a little too large. We select the 8/6 tube to obtain full cylinder velocity.

### Example ②: What cylinder velocity will be obtained?

A 80 mm bore cylinder will be used, connected by 8 m 12/10 tube to a P2L-B valve. What cylinder velocity will we get? We refer to the diagram and follow the line from 8 mm tube length up to the curve for 12/10 tube. From there, we go horizontally to the curve for the Ø80 cylinder. We find that the velocity will be about 0.5 m/s.

### Example ③: What is the minimum inner diameter and maximum length of tube?

For an application a 125 mm bore cylinder will be used. Maximum velocity of piston rod is 0.5 m/s. The cylinder will be controlled by a P2L-D valve. What diameter of tube can be used and what is maximum length of tube. We refer to the diagram. We start at the left side of the diagram cylinder Ø125. We follow the line until the intersection with the velocity line of 0.5 m/s. From here we draw a horizontal line in the diagram. This line shows us we need an equivalent throttling bore of approximately 10 mm. Following this line horizontally we cross a few intersections. These intersections shows us the minimum inner diameter (rightside diagram) in combination with the maximum length of tube (bottomside diagram).

For example:

Intersection one: When a tube (14/11) will be used, the maximum length of tube is 0.7 meter.

Intersection two: When a tube (—/13) will be used, the maximum length of tube is 3.7 meter.

Intersection three: When a tube (—/14) will be used, the maximum length of tube is 6 meter.

### Example ④: Determining tube size and cylinder velocity with a particular cylinder and valve?

For an application using a 40 mm bore cylinder with a valve with Qn=800 NI/min. The distance between the cylinder and valve has been set to 5 m.

**Tube dimension:** What tube bore should be selected to obtain the maximum cylinder velocity? Start at pipe length 5 m, follow the line up to the intersection with 800 NI/min. Select the next largest tube diameter, in this case Ø10/8 mm.

**Cylinder velocity:** What maximum cylinder velocity will be obtained? Follow the line for 800 NI/min to the left until it intersects with the line for the Ø40 mm cylinder. In this example, the speed is just above 1.1 m/s.

### Valve series with respective flows in NI/minute

Valve series	Qn in NI/Min
Valvetronic Solstar	33
Interface PS1	100
Adex A05	173
Moduflex size 1, (2 x 3/2)	220
Valvetronic PVL-B 5/3 closed centre, 6 mm push in	290
Moduflex size 1, (4/2)	320
B43 Manual and mechanical	340
Valvetronic PVL-B 2 x 2/3, 6 mm push in	350
Valvetronic PVL-B 5/3 closed centre, G1/8	370
Compact Isomax DX02	385
Valvetronic PVL-B 2 x 3/2 G1/8	440
Valvetronic PVL-B 5/2, 6 mm push in	450
Valvetronic PVL-B 5/3 vented centre, 6 mm push in	450
Moduflex size 2, (2 x 3/2)	450
Flowstar P2V-A	520
Valvetronic PVL-B 5/3 vented centre, G1/8	540
Valvetronic PVL-B 5/2, G1/8	540
Valvetronic PVL-C 2 x 3/2, 8 mm push in	540
Adex A12	560
Valvetronic PVL-C 2 x 3/2 G1/8	570
Compact Isomax DX01	585
VIKING Xtreme P2LAX	660
Valvetronic PVL-C 5/3 closed centre, 8 mm push in	700
Valvetronic PVL-C 5/3 vented centre, G1/4	700
B3-Series	780
Valvetronic PVL-C 5/3 closed centre, G1/4	780
Moduflex size 2, (4/2)	800
Valvetronic PVL-C 5/2, 8 mm push in	840
Valvetronic PVL-C 5/3 vented centre, 8 mm push in	840
Valvetronic PVL-C 5/2, G1/4	840
Flowstar P2V-B	1090
ISOMAX DX1	1150
B53 Manual and mechanical	1160
B4-Series	1170
VIKING Xtreme P2LBX	1290
B5-Series, G1/4	1440
Airline Isolator Valve VE22/23	1470
ISOMAX DX2	2330
VIKING Xtreme P2LCX, G3/8	2460
VIKING Xtreme P2LDX, G1/2	2660
ISOMAX DX3	4050
Airline Isolator Valve VE42/43	5520
Airline Isolator Valve VE82/83	13680

#### NOTE!

P1K cylinders are equipped with damping cushions, and are therefore designed to reach the following reduced maximum speeds.

Max speed for diameters 3 , 40 and 50 mm is 1.1 m/s

Max speed for diameter 63 mm is 0.8 m/s

Max speed for diameters 80, 100 and 150 mm is 0.6 m/s

## Order key

**P1K - S 032 D**

Cyl. bore mm
032
040
050
063
080
100
125

Cylinder type/Function	
<b>D</b>	Double acting
<b>K</b>	Double acting through rod
<b>S</b>	Single acting spring return For bore 32 - 100
<b>B</b>	Double acting Pin screws and nuts in rear end cover
<b>A</b>	Double acting End cover screws in stainless steel
* Piston rod with female thread, please contact customer service.	

**T - 0100**

**Stroke (mm)**  
E.g. 0025 = 25 mm

For standard stroke length and max length, see table below

Material piston rod				Type of sealing
Stainless steel	Hard chromed steel	Acid-proof steel	Chromed stainl. steel	
A	T	X	1	Standard -20 °C to +80 °C

## Standard stroke length in mm

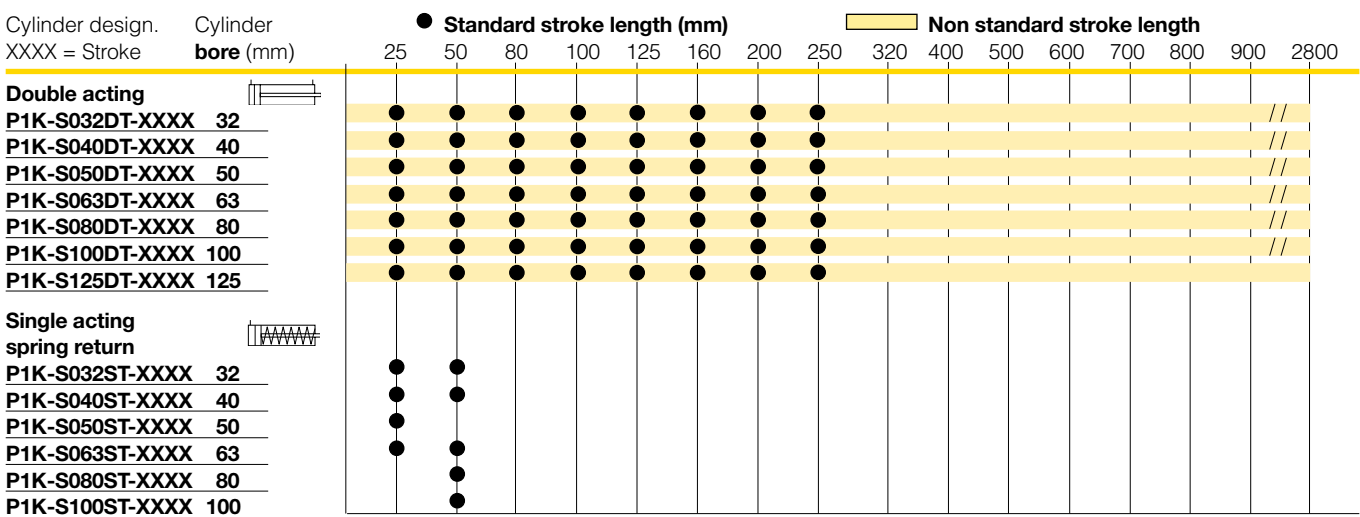

## Double-acting

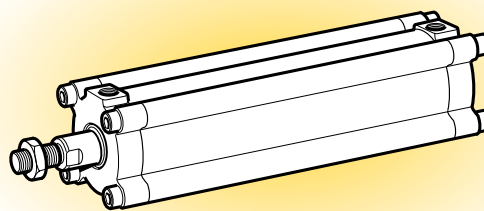
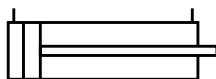

### Fixed end cushioning

Cyl. bore mm	Stroke mm	Order code
<b>32</b> Conn. G1/8	25	P1K-S032DT-0025
	50	P1K-S032DT-0050
	80	P1K-S032DT-0080
	100	P1K-S032DT-0100
	125	P1K-S032DT-0125
	160	P1K-S032DT-0160
	200	P1K-S032DT-0200
<b>40</b> Conn. G1/8	25	P1K-S040DT-0025
	50	P1K-S040DT-0050
	80	P1K-S040DT-0080
	100	P1K-S040DT-0100
	125	P1K-S040DT-0125
	160	P1K-S040DT-0160
	200	P1K-S040DT-0200
<b>50</b> Conn. G1/8	25	P1K-S050DT-0025
	50	P1K-S050DT-0050
	80	P1K-S050DT-0080
	100	P1K-S050DT-0100
	125	P1K-S050DT-0125
	160	P1K-S050DT-0160
	200	P1K-S050DT-0200
<b>63</b> Conn. G1/8	25	P1K-S063DT-0025
	50	P1K-S063DT-0050
	80	P1K-S063DT-0080
	100	P1K-S063DT-0100
	125	P1K-S063DT-0125
	160	P1K-S063DT-0160
	200	P1K-S063DT-0200
<b>80</b> Conn. G1/4	25	P1K-S080DT-0025
	50	P1K-S080DT-0050
	80	P1K-S080DT-0080
	100	P1K-S080DT-0100
	125	P1K-S080DT-0125
	160	P1K-S080DT-0160
	200	P1K-S080DT-0200
<b>100</b> Conn. G1/4	25	P1K-S100DT-0025
	50	P1K-S100DT-0050
	80	P1K-S100DT-0080
	100	P1K-S100DT-0100
	125	P1K-S100DT-0125
	160	P1K-S100DT-0160
	200	P1K-S100DT-0200
<b>125</b> Conn. G3/8	25	P1K-S125DT-0025
	50	P1K-S125DT-0050
	80	P1K-S125DT-0080
	100	P1K-S125DT-0100
	125	P1K-S125DT-0125
	160	P1K-S125DT-0160
	200	P1K-S125DT-0200

The cylinders are supplied complete with one zinc plated steel piston rod nut.

### Fixed end cushioning

Cyl. bore mm	Stroke mm	Order code
<b>80</b> Conn. G1/4	25	P1K-S080DT-0025
	50	P1K-S080DT-0050
	80	P1K-S080DT-0080
	100	P1K-S080DT-0100
	125	P1K-S080DT-0125
	160	P1K-S080DT-0160
	200	P1K-S080DT-0200
<b>100</b> Conn. G1/4	25	P1K-S100DT-0025
	50	P1K-S100DT-0050
	80	P1K-S100DT-0080
	100	P1K-S100DT-0100
	125	P1K-S100DT-0125
	160	P1K-S100DT-0160
	200	P1K-S100DT-0200
<b>125</b> Conn. G3/8	25	P1K-S125DT-0025
	50	P1K-S125DT-0050
	80	P1K-S125DT-0080
	100	P1K-S125DT-0100
	125	P1K-S125DT-0125
	160	P1K-S125DT-0160
	200	P1K-S125DT-0200

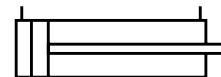

## Single-acting, spring return

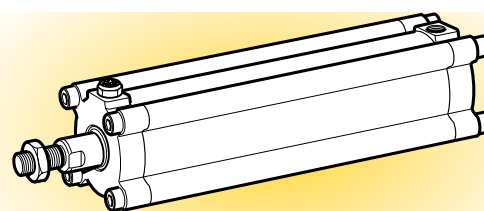
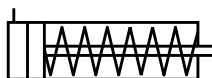

### Fixed end cushioning

Cyl. bore mm	Stroke mm	Order code
<b>32</b> Conn. G1/8	25	P1K-S032ST-0025
	50	P1K-S032ST-0050
<b>40</b> Conn. G1/8	25	P1K-S040ST-0025
	50	P1K-S040ST-0050
<b>50</b> Conn. G1/8	25	P1K-S050ST-0025
<b>63</b> Conn. G1/8	25	P1K-S063ST-0025
	50	P1K-S063ST-0050
<b>80</b> Conn. G1/4	50	P1K-S080ST-0050
<b>100</b> Conn. G1/4	50	P1K-S100ST-0050

The cylinders are supplied complete with one zinc plated steel piston rod nut.

Order key, special versions

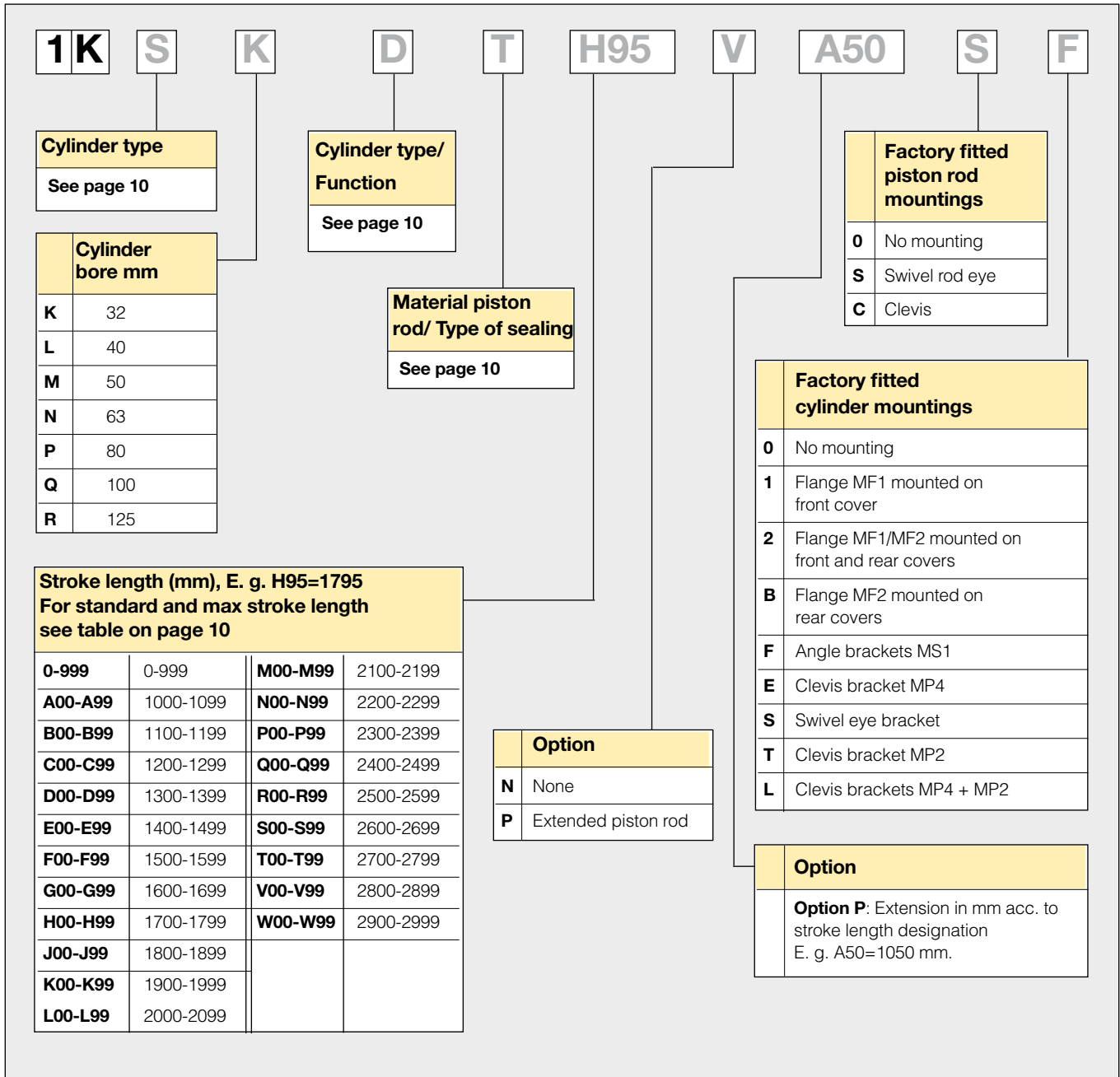

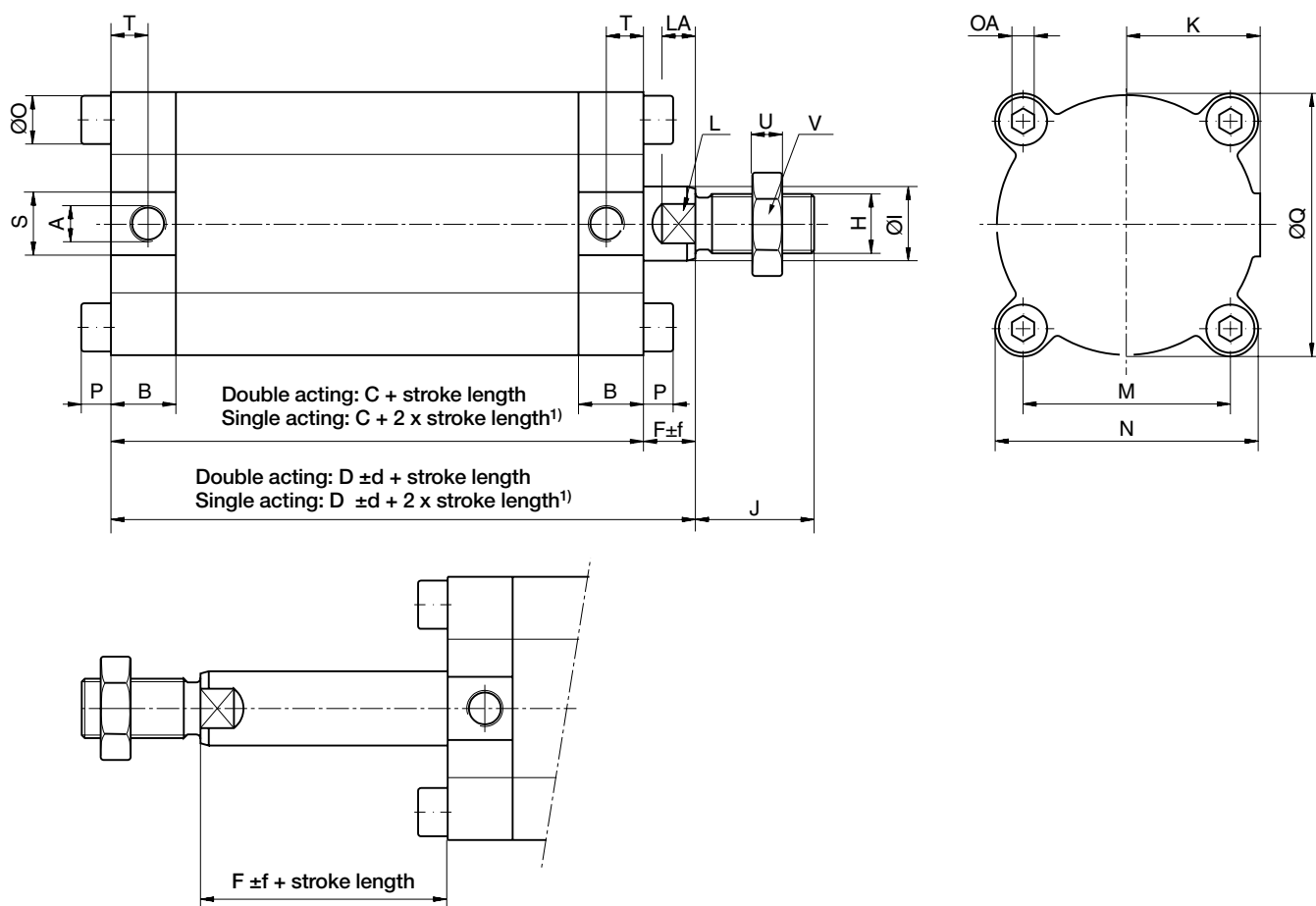

## Dimensions

Cylinder designation	A	B	C	D	F	H	I	J	K	L	LA	M	N	O	OA	P	Q	S
		mm	mm	mm	mm		mm	mm	mm	mm	mm	mm	mm	mm	mm	mm	mm	mm
P1K-S032	G1/8	17,0	65,0	75,0	10	M10x1,25	12	22	21,0	10	6	32,5	42,5	8,5	4	5	37	17
P1K-S040	G1/8	17,0	65,0	78,0	13	M12x1,25	16	24	24,0	14	9	36,8	48,0	10,0	5	6	45	17
P1K-S050	G1/8	17,5	71,0	85,0	14	M16x1,5	20	32	29,0	17	9	46,7	59,0	10,0	5	6	56	17
P1K-S063	G1/8	17,5	72,0	86,0	14	M16x1,5	20	32	36,0	17	9	55,9	71,0	13,0	6	8	70	17
P1K-S080	G1/4	21,5	85,0	101,0	16	M20x1,5	25	40	44,5	22	10	70,0	87,0	16,0	8	10	87	21
P1K-S100	G1/4	21,5	87,0	108,0	21	M20x1,5	32	40	55,0	27	13	84,1	102,0	16,0	8	10	108	21
P1K-S125	G3/8	25,5	94,5	115,5	21	M27x2	32	54	68,0	27	13	104,0	124,0	18,0	10	12	134	25

## Dimensions

Cylinder designation	T	U	V	Dimensions D and F		Stroke length 0-320 mm (at 6 bar) mm
	mm	mm	mm	d	f	
	mm	mm	mm	mm	mm	
P1K-S032	10	5,0	17	0,9	1,2	+2,0
P1K-S040	10	6,0	19	0,9	1,2	+2,0
P1K-S050	10	8,0	24	0,9	1,2	+2,0
P1K-S063	10	8,0	24	1,2	1,6	+2,5
P1K-S080	12	10,0	30	1,2	1,6	+2,5
P1K-S100	12	10,0	30	1,2	1,6	+2,5
P1K-S125	14	13,5	41	1,2	1,6	+2,5

1) Stroke length for dimensions 32-63 = 25 and 50 mm, for dimensions 80-100 = 50 mm.

## Cylinder mountings

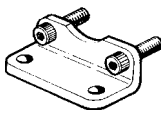
Type	Description	Cyl. bore Ø mm	Weight kg	Order code
<b>Foot bracket MS1</b> 	Intended for fixed mounting of cylinder. This bracket can be fitted to front and rear end covers.  Material Body galvanized steel. These brackets are supplied in pairs.  <b>When fitting:</b> <i>Remove the bolts from the cylinder end cover and fit the bracket, using the same bolts. The bolts supplied with the mount are intended for use with another range of cylinders and must not be used with the P1K range.</i>	32	0,08	<b>9121644801</b>
		40	0,11	<b>9121644802</b>
		50	0,18	<b>9121644803</b>
		63	0,26	<b>9121644804</b>
		80	0,50	<b>9121644805</b>
		100	0,80	<b>9121644806</b>
		125	1,40	<b>9121644807</b>

Cyl. Ø mm	A mm	B mm	C mm	D mm	E mm	F mm	G mm	H mm	I mm	K mm
32	48	32	5,0	32	53	7	24	32	113,0	99,0
40	54	36	5,0	36	60	9	31	42	127,0	109,0
50	64	45	6,0	45	75	9	33	45	137,0	118,0
63	76	50	6,0	50	86	9	36	48	144,0	122,0
80	94	63	8,0	63	107	12	43	58	171,0	144,0
100	110	75	10,5	71	122	14	43	60	173,0	151,0
125	135	90	12,5	90	157	16	45	70	184,5	160,5

S=stroke length

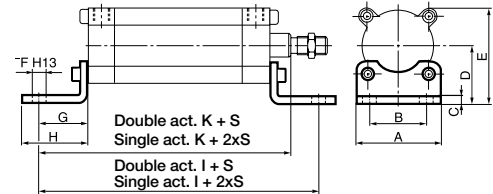

## Flange MF1 and MF2

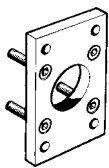

Intended for fixed mounting of cylinder. This bracket can be fitted to front and rear end covers.  
  
Material  
Diam. 32 - 63 mm: flange anodised aluminium  
Diam. 80 - 125 mm: flange galvanized steel  
The flange is supplied complete with screws for mounting on the cylinder.

32	0,26	<b>9121644901</b>
40	0,37	<b>9121644902</b>
50	0,52	<b>9121644903</b>
63	0,90	<b>9121644904</b>
80	1,59	<b>9121644905</b>
100	2,19	<b>9121644906</b>
125	3,90	<b>9121644907</b>

**When fitting:**  
*Remove the bolts from the cylinder end cover and fit the bracket, using the same bolts. The bolts supplied with the mount are intended for use with another range of cylinders and must not be used with the P1K range.*

Cyl. Ø mm	A mm	B mm	C mm	D mm	E mm	F mm	G mm	H mm	I mm
32	80	64	48	32	7	10	0	86,0	27
40	90	72	54	36	9	13	0	91,0	32
50	110	90	64	45	9	13	1	98,0	40
63	120	100	76	50	9	16	-2	102,0	40
80	155	126	94	63	12	18	-2	119,0	50
100	180	150	110	75	14	18	3	126,0	60
125	220	180	135	90	16	20	1	135,5	72

S=stroke length

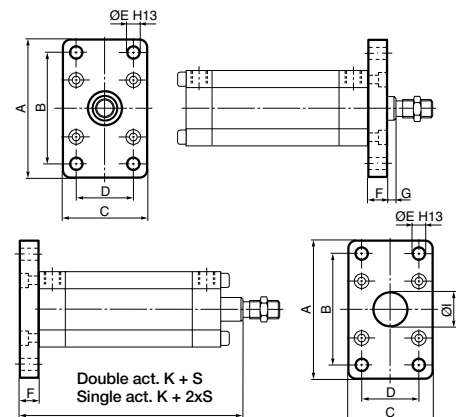

## Cylinder mountings

Type	Description	Cyl. bore Ø mm	Weight kg	Order code
<b>Clevis bracket MP4</b>	Intended for flexible mounting of cylinder. This bracket can be combined with clevis bracket MP2 and swivel rod bracket.  Materials: Body anodised aluminium and shaft of hardened steel. The mount is supplied complete with shaft.	32	0,05	<b>9121644601</b>
		40	0,13	<b>9121644602</b>
		50	0,18	<b>9121644603</b>
		63	0,34	<b>9121644604</b>
		80	0,57	<b>9121644605</b>
		100	0,91	<b>9121644606</b>
		125	2,90	<b>9121644607</b>

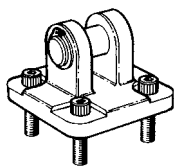

### When fitting:

Remove the bolts from the cylinder end cover and fit the mount, using the same bolts. The bolts supplied with the mount are intended for use with another range of cylinders and must not be used with the P1K range.

Cyl. Ø mm	A mm	B mm	C mm	D mm	E mm	F mm	G mm	H mm	I mm	K mm
32	48	22	33	26	10	10	11	15,0	22	97,0
40	54	24	35	28	12	12	12	21,0	28	106,0
50	64	32	39	32	12	12	13	19,5	28	113,0
63	76	39	47	40	16	16	17	26,0	36	122,0
80	94	48	57	50	16	16	17	26,0	38	139,0
100	110	62	67	60	20	20	21	29,0	43	151,0
125	135	70	77	70	25	25	26	35,0	50	165,5

S=stroke length

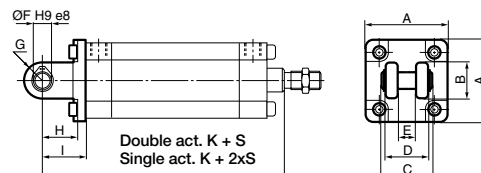

## Clevis bracket MP2

Intended for flexible mounting of cylinder. This bracket can be combined with clevis bracket MP4.

Materials:  
Body anodised aluminium and shaft of hardened steel.  
The mount is supplied complete with shaft.

### When fitting:

Remove the bolts from the cylinder end cover and fit the mount, using the same bolts. The bolts supplied with the mount are intended for use with another range of cylinders and must not be used with the P1K range.

Cyl. Ø mm	A mm	B mm	C mm	D mm	E mm	F mm	G mm	H mm	I mm	K mm
32	48	22	52	45	26	10	11	15,0	22	97,0
40	54	24	59	52	28	12	12	21,0	28	106,0
50	64	32	67	60	32	12	13	19,5	28	113,0
63	76	39	77	70	40	16	17	26,0	36	122,0
80	94	48	97	90	50	16	17	26,0	38	139,0
100	110	62	117	110	60	20	21	29,0	43	151,0
125	135	70	137	130	70	25	26	35,0	50	165,5

S=stroke length

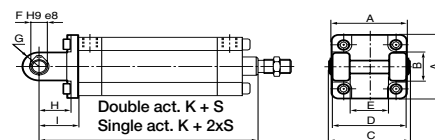

## Swivel rod bracket

Intended for flexible mounting of cylinder. The swivel rod permits lateral articulation. The bracket can be combined with clevis bracket MP4.

Materials:  
Body anodised aluminium and swivel bearing of hardened steel.

### When fitting:

Remove the bolts from the cylinder end cover and fit the mount, using the same bolts. The bolts supplied with the mount are intended for use with another range of cylinders and must not be used with the P1K range.

Cyl. Ø mm	A mm	B mm	C mm	D mm	F mm	G mm	H mm	I mm	K mm
32	48	9	7,5	13,0	10	12,5	15,0	22	97,0
40	54	12	9,0	15,5	12	15,5	21,0	28	106,0
50	64	12	9,0	15,5	12	16,5	19,5	28	113,0
63	76	16	12,5	20,0	16	19,5	26,0	36	122,0
80	94	16	12,5	20,0	16	21,5	26,0	38	139,0
100	110	20	16,0	25,0	20	25,5	29,0	43	151,0
125	135	25	20,5	30,5	25	30,0	35,0	50	165,5

S=stroke length

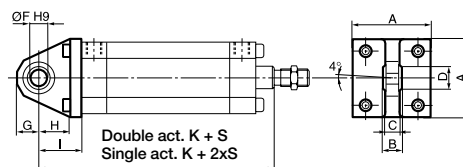

## Piston rod mountings

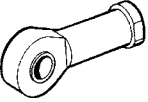
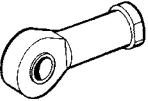
Type	Description	Cyl. bore Ø mm	Weight kg	Order code
<b>Swivel rod eye</b> 	Intended for articulated mounting of the cylinder. Maintenance-free PTFE.  Material: Swivel rod eye, nut: galvanized steel. Swivel bearing according to DIN 648K: Hardened steel.	32	0,08	<b>P1C-4KRS</b> <b>P1C-4LRS</b> <b>P1C-4MRS</b> <b>P1C-4MRS</b> <b>P1C-4PRS</b> <b>P1C-4PRS</b> <b>P1C-4RRS</b>
		40	0,12	
		50	0,25	
		63	0,25	
		80	0,46	
		100	0,46	
<b>Stainless steel swivel rod eye</b> 	Stainless-steel swivel rod eye for articulated mounting of cylinder. Maintenance-free.  Materials Swivel rod eye: Stainless steel Swivel bearing according to DIN 648K: Stainless steel Use stainless steel nut (see page 17) with stainless steel swivel rod eye.	32	0,08	<b>P1S-4JRT</b> <b>P1S-4LRT</b> <b>P1S-4MRT</b> <b>P1S-4MRT</b> <b>P1S-4PRT</b> <b>P1S-4PRT</b> <b>P1S-4RRT</b>
		40	0,12	
		50	0,25	
		63	0,25	
		80	0,46	
		100	0,46	
125	1,28			

### ISO 8139

Cyl.- dia. mm	A mm	B min max mm	B max mm	CE mm	CN H9 mm	EN h12 mm	ER mm	KK mm	LE min mm	N* mm	O mm	Z °
32	20	48,0	55	43	10	14	14	M10x1,25	15	17	10,5	12°
40	22	56,0	62	50	12	16	16	M12x1,25	17	19	12,0	12°
50	28	72,0	80	64	16	21	21	M16x1,5	22	22	15,0	15°
63	28	72,0	80	64	16	21	21	M16x1,5	22	22	15,0	15°
80	33	87,0	97	77	20	25	25	M20x1,5	26	32	18,0	15°
100	33	87,0	97	77	20	25	25	M20x1,5	26	32	18,0	15°
125	51	123,5	137	110	30	37	35	M27x2	36	41	25,0	15°

\*key grip

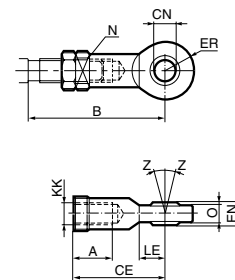

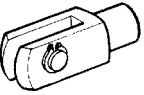
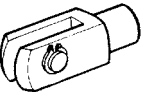
<b>Clevis</b> 	Intended for articulated mounting of the cylinder.  Material: Clevis and clip galvanized steel. Pin: Hardened steel  Supplied complete with axle.	32	0,09	<b>P1C-4KRC</b> <b>P1C-4LRC</b> <b>P1C-4MRC</b> <b>P1C-4MRC</b> <b>P1C-4PRC</b> <b>P1C-4PRC</b> <b>P1C-4RRC</b>
		40	0,15	
		50	0,35	
		63	0,35	
		80	0,75	
		100	0,75	
<b>Stainless steel clevis</b> 	Stainless-steel clevis for articulated mounting of cylinder.  Material Clevis: Stainless steel Pin: Stainless steel Circlips according to DIN 471: Stainless steel Use stainless steel nut (see page 17) with stainless steel swivel rod eye.	32	0,09	<b>P1S-4JRD</b> <b>P1S-4LRD</b> <b>P1S-4MRD</b> <b>P1S-4MRD</b> <b>P1S-4PRD</b> <b>P1S-4PRD</b> <b>P1S-4RRD</b>
		40	0,15	
		50	0,35	
		63	0,35	
		80	0,75	
		100	0,75	
125	2,10			

### ISO 8140

Cyl.- dia. mm	A mm	B min max mm	B max mm	CE mm	CK h11/E9 mm	CL mm	CM mm	ER mm	KK mm	LE mm	O mm
32	20	45,0	52	40	10	20	10	16	M10x1,25	20	28,0
40	24	54,0	60	48	12	24	12	19	M12x1,25	24	32,0
50	32	72,0	80	64	16	32	16	25	M16x1,5	32	41,5
63	32	72,0	80	64	16	32	16	25	M16x1,5	32	41,5
80	40	90,0	100	80	20	40	20	32	M20x1,5	40	50,0
100	40	90,0	100	80	20	40	20	32	M20x1,5	40	50,0
125	56	123,5	137	110	30	55	30	45	M27x2	54	72,0

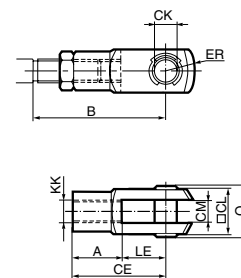



## Piston rod mountings

Type	Description	Cyl. bore Ø mm	Weight kg	Order code
<b>Flexo coupling</b>	Flexo coupling for articulated mounting of piston rod. Flexo fitting is intended to take up axial angle errors within a range of $\pm 4^\circ$ .  Material Flexo coupling, nut: Zinc-plated steel Socket: Hardened steel Supplied complete with galvanized adjustment nut.	32	0,21	<b>P1C-4KRF</b> <b>P1C-4LRF</b> <b>P1C-4MRF</b> <b>P1C-4MRF</b> <b>P1C-4PRF</b> <b>P1C-4PRF</b> <b>P1C-4RRF</b>
		40	0,22	
		50	0,67	
		63	0,67	
		80	0,72	
		100	0,72	
125	1,80			

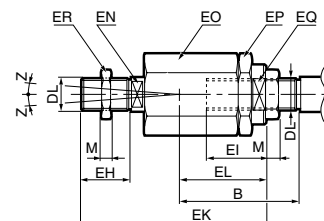
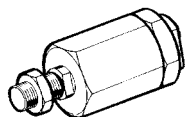

Cyl.-bore mm	B min mm	B max mm	DL	EH	EI	EK	EL	EN	EO	EP	EQ	ER	M	Z
32	36,0	43	M10x1,25	20	23	70	31	12	30	30	19	30	5,0	4°
40	37,0	43	M12x1,25	23	23	67	31	12	30	30	19	30	6,0	4°
50	53,0	61	M16x1,5	40	32	112	45	19	41	41	30	41	8,0	4°
63	53,0	61	M16x1,5	40	32	112	45	19	41	41	30	41	8,0	4°
80	57,0	67	M20x1,5	39	42	122	56	19	41	41	30	41	10,0	4°
100	57,0	67	M20x1,5	39	42	122	56	19	41	41	30	41	10,0	4°
125	75,5	89	M27x2	48	48	145	60	24	55	55	32	55	13,5	4°

<b>Piston rod nut</b>	Intended for fixed mounting of accessories to the piston rod.  Material: Zinc-plated steel  The cylinders are supplied complete with one zinc plated steel piston rod nut.	32	0,007	<b>9128985601</b> <b>0261109910</b> <b>9128985603</b> <b>9128985603</b> <b>0261109911</b> <b>0261109911</b> <b>0261109912</b>
		40	0,010	
		50	0,021	
		63	0,021	
		80	0,040	
		100	0,040	
125	0,100			
<b>Stainless steel nut</b>	Intended for fixed mounting of accessories to the piston rod.  Material: Stainless steel A2  The cylinders are supplied complete with one zinc plated steel piston rod nut.	32	0,007	<b>9126725404</b> <b>9126725405</b> <b>9126725406</b> <b>9126725406</b> <b>0261109921</b> <b>0261109921</b> <b>0261109922</b>
		40	0,010	
		50	0,021	
		63	0,021	
		80	0,040	
		100	0,040	
125	0,100			
<b>Acid-proof nut</b>	Intended for fixed mounting of accessories to the piston rod.  Material: Acid-proof steel A4  Cylinders with acid-proof piston rod are supplied with nut of acid-proof steel	32	0,007	<b>0261109919</b> <b>0261109920</b> <b>0261109917</b> <b>0261109917</b> <b>0261109916</b> <b>0261109916</b> <b>0261109918</b>
		40	0,010	
		50	0,021	
		63	0,021	
		80	0,040	
		100	0,040	
125	0,100			

Enligt DIN 439 B

Cyl. Ø mm	A mm	B mm	C
32	17	5,0	M10x1,25
40	19	6,0	M12x1,25
50	24	8,0	M16x1,5
63	24	8,0	M16x1,5
80	30	10,0	M20x1,5
100	30	10,0	M20x1,5
125	41	13,5	M27x2

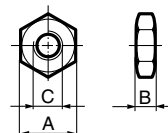

## Combinations

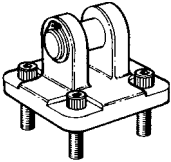
Type	Description	Cyl. bore Ø mm	Order code	Order code
<b>Clevis bracket MP4</b>	<b>Clevis bracket MP2</b> In this combination the clevis bracket MP4 is attached to the indicated cylinder.	32	MP4 <b>9121644601</b>	MP2 <b>9121644701</b>
		40	<b>9121644602</b>	<b>9121644702</b>
		50	<b>9121644603</b>	<b>9121644703</b>
		63	<b>9121644604</b>	<b>9121644704</b>
		80	<b>9121644605</b>	<b>9121644705</b>
		100	<b>9121644606</b>	<b>9121644706</b>
		125	<b>9121644607</b>	<b>9121644707</b>

Cyl. Ø mm	A mm	B mm	C mm	D mm	E mm	F mm	G mm	H mm	I mm	K mm	L
32	48	32,5	5,5	7,0	15,0	22	44	97,0	119,0	52	104°
40	54	36,8	6,6	7,0	21,0	28	56	106,0	134,0	59	130°
50	64	46,7	6,6	8,5	19,5	28	56	113,0	141,0	67	120°
63	76	55,9	9,0	10,0	26,0	36	72	122,0	158,0	77	110°
80	94	70,0	11,0	12,0	26,0	38	76	139,0	177,0	97	80°
100	110	84,1	11,0	14,0	29,0	43	86	146,0	189,0	117	82°
125	135	104,0	14,0	15,0	35,0	50	100	165,5	215,5	137	82°

S=stroke length

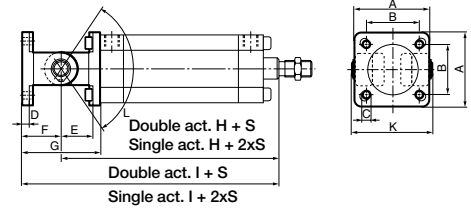

## Swivel rod bracket

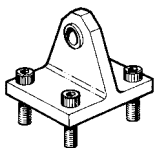

## Clevis bracket MP4

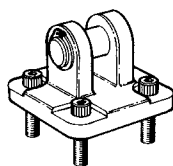

In this combination the swivel rod bracket is attached to the indicated cylinder.

32  
40  
50  
63  
80  
100  
125

## Swivel rod bracket MP4

**9121568601** **9121644601**  
**9121568602** **9121644602**  
**9121568603** **9121644603**  
**9121568604** **9121644604**  
**9121568605** **9121644605**  
**9121568606** **9121644606**  
**9121568607** **9121644607**

Cyl. Ø mm	A mm	B mm	C mm	D mm	E mm	F mm	G mm	H mm	I mm	K mm	L
32	48	32,5	5,5	7,0	15,0	22	44	97,0	119,0	104°	5,7°
40	54	36,8	6,6	7,0	21,0	28	56	106,0	134,0	130°	5,5°
50	64	46,7	6,6	8,5	19,5	28	56	113,0	141,0	120°	5,2°
63	76	55,9	9,0	10,0	26,0	36	72	122,0	158,0	110°	5,1°
80	94	70,0	11,0	12,0	26,0	38	76	139,0	177,0	80°	4,6°
100	110	84,1	11,0	14,0	29,0	43	86	146,0	189,0	82°	4,4°
125	135	104,0	14,0	15,0	35,0	50	100	165,5	215,5	82°	4,4°

S=stroke length

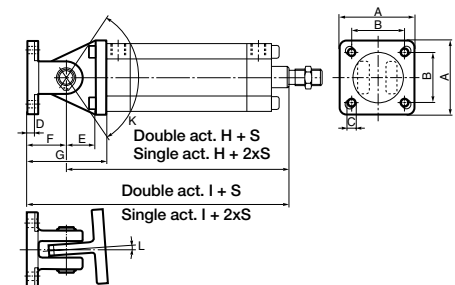

## Fitted VikingXtreme Valve

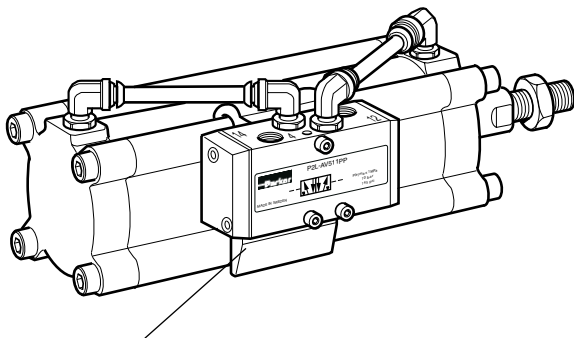

Mounting plate in aluminium profile. for fitted valve.

## Material specification

Mounting plate	Anodised aluminium
Mounting screws for plate	Stainless steel
Mounting screws for valve	Zinc-plated steel

## Accessories

Description	Order code
Silencer (Siflow) for P2LAX valve, G1/8	<b>9301050901</b>
Silencer (sintered plastic) for P2LAX valve, G1/8	<b>P6M-PAB1</b>
Mounting plate P2LAX P1K- Ø32, Ø40	<b>9122520050</b>
Mounting plate P2LAX P1K- Ø50, Ø63	<b>9122520051</b>
Mounting plate P2LAX P1K- Ø80	<b>9122520052</b>

## Tightening torques

When attaching mountings, the bolts should be tightened to the following torques.

If other types of mounting are used, the following maximum metal thicknesses apply when using the cylinder end cover bolts.

Cylinder bore mm	Tightening torque Nm	Maximum metal thickness mm
32	4,5±0,5	7,0
40	8±0,8	7,0
50	8±0,8	8,5
63	20±2	10,0
80	40±4	12,0
100	40±4	14,0
125	60±6	15,0

## Seal kits for complete P1K cylinder

Cyl. bore mm	Option			
	Standard	High Temp.	Low Temp.	Hydraulic
32	9122352088	9122421921	P1K-6032PL	9122421931
40	9122352089	9122421922	P1K-6040PL	9122421932
50	9122352090	9122421923	P1K-6050PL	9122421933
63	9122352091	9122421924	P1K-6063PL	9122421934
80	9122352092	9122421925	P1K-6080PL	9122421935
100	9122352093	9122421926	P1K-6100PL	9122421936
125	9122352100	*	*	9122421937

\* Please contact customer service.

## Grease for P1K

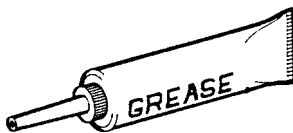

Standard	30g	9127394541
High temperature	30g	9127394521
Low temperature	30g	9127394541

# Parker Worldwide

**AE – UAE, Dubai**  
Tel: +971 4 8127100  
parker.me@parker.com

**AR – Argentina, Buenos Aires**  
Tel: +54 3327 44 4129

**AT – Austria, Wiener Neustadt**  
Tel: +43 (0)2622 23501-0  
parker.austria@parker.com

**AT – Eastern Europe, Wiener Neustadt**  
Tel: +43 (0)2622 23501 900  
parker.easteurope@parker.com

**AU – Australia, Castle Hill**  
Tel: +61 (0)2-9634 7777

**AZ – Azerbaijan, Baku**  
Tel: +994 50 2233 458  
parker.azerbaijan@parker.com

**BE/LU – Belgium, Nivelles**  
Tel: +32 (0)67 280 900  
parker.belgium@parker.com

**BR – Brazil, Cachoeirinha RS**  
Tel: +55 51 3470 9144

**BY – Belarus, Minsk**  
Tel: +375 17 209 9399  
parker.belarus@parker.com

**CA – Canada, Milton, Ontario**  
Tel: +1 905 693 3000

**CH – Switzerland, Etoy**  
Tel: +41 (0) 21 821 02 30  
parker.switzerland@parker.com

**CL – Chile, Santiago**  
Tel: +56 2 623 1216

**CN – China, Shanghai**  
Tel: +86 21 5031 2525

**CZ – Czech Republic, Klecany**  
Tel: +420 284 083 111  
parker.czechrepublic@parker.com

**DE – Germany, Kaarst**  
Tel: +49 (0)2131 4016 0  
parker.germany@parker.com

**DK – Denmark, Ballerup**  
Tel: +45 43 56 04 00  
parker.denmark@parker.com

**ES – Spain, Madrid**  
Tel: +34 902 33 00 01  
parker.spain@parker.com

**FI – Finland, Vantaa**  
Tel: +358 (0)20 753 2500  
parker.finland@parker.com

**FR – France, Contamine s/Arve**  
Tel: +33 (0)4 50 25 80 25  
parker.france@parker.com

**GR – Greece, Athens**  
Tel: +30 210 933 6450  
parker.greece@parker.com

**HK – Hong Kong**  
Tel: +852 2428 8008

**HU – Hungary, Budapest**  
Tel: +36 1 220 4155  
parker.hungary@parker.com

**IE – Ireland, Dublin**  
Tel: +353 (0)1 466 6370  
parker.ireland@parker.com

**IN – India, Mumbai**  
Tel: +91 22 6513 7081-85

**IT – Italy, Corsico (MI)**  
Tel: +39 02 45 19 21  
parker.italy@parker.com

**JP – Japan, Tokyo**  
Tel: +(81) 3 6408 3901

**KR – South Korea, Seoul**  
Tel: +82 2 559 0400

**KZ – Kazakhstan, Almaty**  
Tel: +7 7272 505 800  
parker.easteurope@parker.com

**LV – Latvia, Riga**  
Tel: +371 6 745 2601  
parker.latvia@parker.com

**MX – Mexico, Apodaca**  
Tel: +52 81 8156 6000

**MY – Malaysia, Shah Alam**  
Tel: +60 3 7849 0800

**NL – The Netherlands, Oldenzaal**  
Tel: +31 (0)541 585 000  
parker.nl@parker.com

**NO – Norway, Ski**  
Tel: +47 64 91 10 00  
parker.norway@parker.com

**NZ – New Zealand, Mt Wellington**  
Tel: +64 9 574 1744

**PL – Poland, Warsaw**  
Tel: +48 (0)22 573 24 00  
parker.poland@parker.com

**PT – Portugal, Leca da Palmeira**  
Tel: +351 22 999 7360  
parker.portugal@parker.com

**RO – Romania, Bucharest**  
Tel: +40 21 252 1382  
parker.romania@parker.com

**RU – Russia, Moscow**  
Tel: +7 495 645-2156  
parker.russia@parker.com

**SE – Sweden, Spånga**  
Tel: +46 (0)8 59 79 50 00  
parker.sweden@parker.com

**SG – Singapore**  
Tel: +65 6887 6300

**SK – Slovakia, Banská Bystrica**  
Tel: +421 484 162 252  
parker.slovakia@parker.com

**SL – Slovenia, Novo Mesto**  
Tel: +386 7 337 6650  
parker.slovenia@parker.com

**TH – Thailand, Bangkok**  
Tel: +662 717 8140

**TR – Turkey, Istanbul**  
Tel: +90 216 4997081  
parker.turkey@parker.com

**TW – Taiwan, Taipei**  
Tel: +886 2 2298 8987

**UA – Ukraine, Kiev**  
Tel: +380 44 494 2731  
parker.ukraine@parker.com

**UK – United Kingdom, Warwick**  
Tel: +44 (0)1926 317 878  
parker.uk@parker.com

**US – USA, Cleveland**  
Tel: +1 216 896 3000

**VE – Venezuela, Caracas**  
Tel: +58 212 238 5422

**ZA – South Africa, Kempton Park**  
Tel: +27 (0)11 961 0700  
parker.southafrica@parker.com

European Product Information Centre

Free phone: 00 800 27 27 5374

(from AT, BE, CH, CZ, DE, DK, ES, FI, FR, IE, IT, NL, NO, PL, PT, RU, SE, UK, ZA)



## Parker Hannifin Ltd

Pneumatic Division Europe  
The Collins Centre,  
Lichfield South, Wall Island,  
Birmingham Road, Lichfield.  
WS14 0QP United Kingdom  
Tel.: +44 (0) 1543 483800  
Fax: +44 (0) 1543 483801  
[www.parker.com/euro\\_pneumatic](http://www.parker.com/euro_pneumatic)