

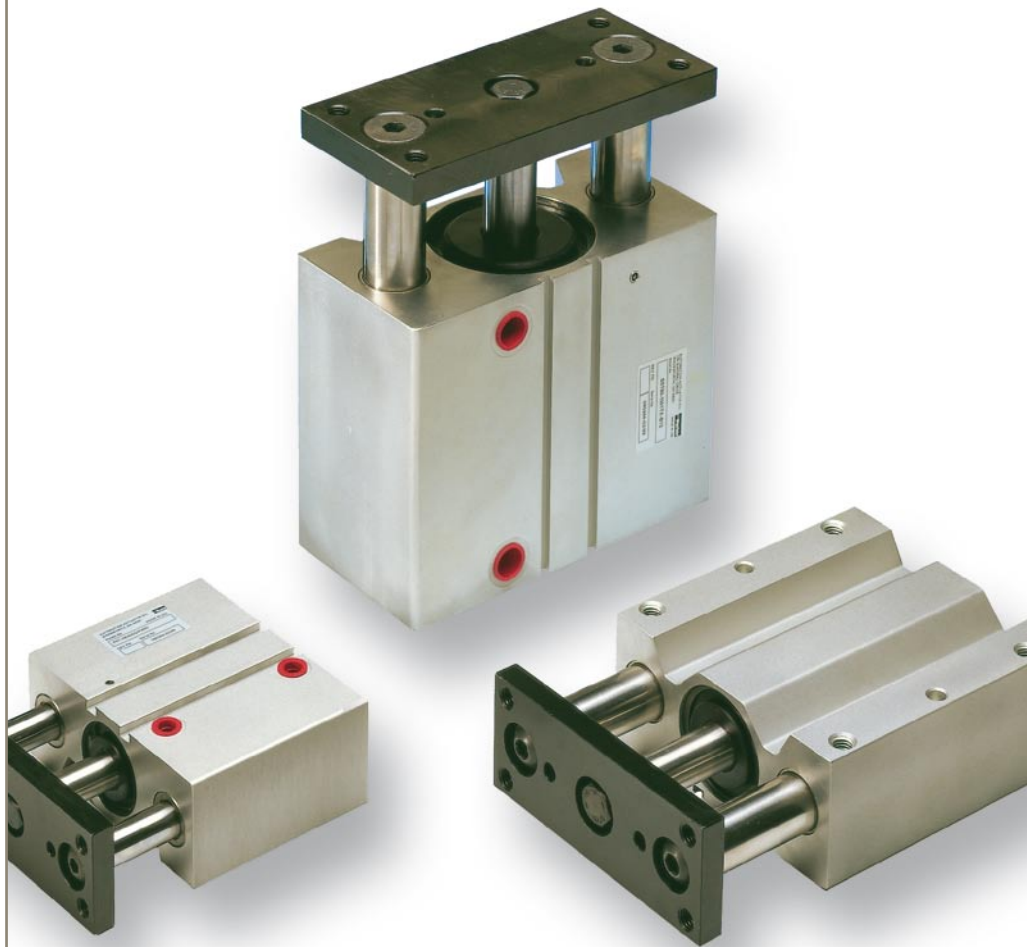

aerospace  
climate control  
electromechanical  
filtration  
fluid & gas handling  
hydraulics  
**pneumatics**  
process control  
sealing & shielding



# Pneumatic cylinders

Series P5T  
Short Stroke Thrusters



ENGINEERING YOUR SUCCESS.

Features	Air cylinder	Hydraulic cylinder	Electro mechanical actuators
Overload safe	***	***	*
Easy to limit force	***	***	*
Easy to vary speed	***	***	*
Speed	***	**	**
Reliability	***	***	***
Robustness	***	***	*
Installation cost	***	*	**
Ease of service	***	**	*
Safety in damp environments	***	***	*
Safety in explosive atmospheres	***	***	*
Safety risk with electrical installations	***	***	*
Risk of oil leak	***	*	***
Clean, hygienic	***	**	*
Standardised measurements	***	***	*
Service life	***	***	*
Hydraulic system required	***	*	***
Weight	***	**	**
Purchase price	***	**	*
Power density	**	***	*
Noise level during operation	**	***	**
High force for size	**	***	*
Positioning possibilities	*	***	***
Total energy consumption	*	**	***
Service interval	*	**	***
Compressor capacity required	*	***	***

\* = good, \*\*=average, \*\*\*=excellent



**Important**  
 Before attempting any external or internal work on the cylinder or any connected components, make sure the cylinder is vented and disconnect the air supply in order to ensure isolation of the air supply.



**Note**  
 All technical data in this catalogue are typical data only.  
 Air quality is essential for maximum cylinder service life (see ISO 8573).



**WARNING**

**FAILURE OR IMPROPER SELECTION OR IMPROPER USE OF THE PRODUCTS AND/OR SYSTEMS DESCRIBED HEREIN OR RELATED ITEMS CAN CAUSE DEATH, PERSONAL INJURY AND PROPERTY DAMAGE.**

This document and other information from Parker Hannifin Corporation, its subsidiaries and authorized distributors provide product and/or system options for further investigation by users having technical expertise. It is important that you analyze all aspects of your application and review the information concerning the product or system in the current product catalog. Due to the variety of operating conditions and applications for these products or systems, the user, through its own analysis and testing, is solely responsible for making the final selection of the products and systems and assuring that all performance, safety and warning requirements of the application are met. The products described herein, including without limitation, product features, specifications, designs, availability and pricing, are subject to change by Parker Hannifin Corporation and its subsidiaries at any time without notice.

**SALE CONDITIONS**

The items described in this document are available for sale by Parker Hannifin Corporation, its subsidiaries or its authorized distributors. Any sale contract entered into by Parker will be governed by the provisions stated in Parker's standard terms and conditions of sale (copy available upon request).

<b>Contents</b>	<b>Page</b>
P5T Cylinder, general information .....	4-5
Cylinder forces .....	6
Working medium, air quality .....	6
Main data.....	7
Material specification .....	7
Guide for selecting suitable tubing .....	8
Valve series with respective flows in NI/minute .....	9
Dimensions, P5T.....	10-12
Maximum load .....	13
Maximum Torsional Capacity for Symmetrical Torsion .....	14
Maximum Torsional Capacity for Asymmetrical Torque.....	15
Maximum load during vertical lift.....	16
Maximum loading as a stop cylinder.....	17
Ordering key.....	18
Standard strokes .....	18
Order code standard strokes, double acting P5T with plain bearing.....	19
Sensors.....	20-24
Connecting cables with one connector.....	25
Male connectors for connecting cables .....	25
Ready to use connecting cables with connectors at each end .....	25
Connection block Valvetronic 110 .....	26
Seal kits and grease for P5T.....	27

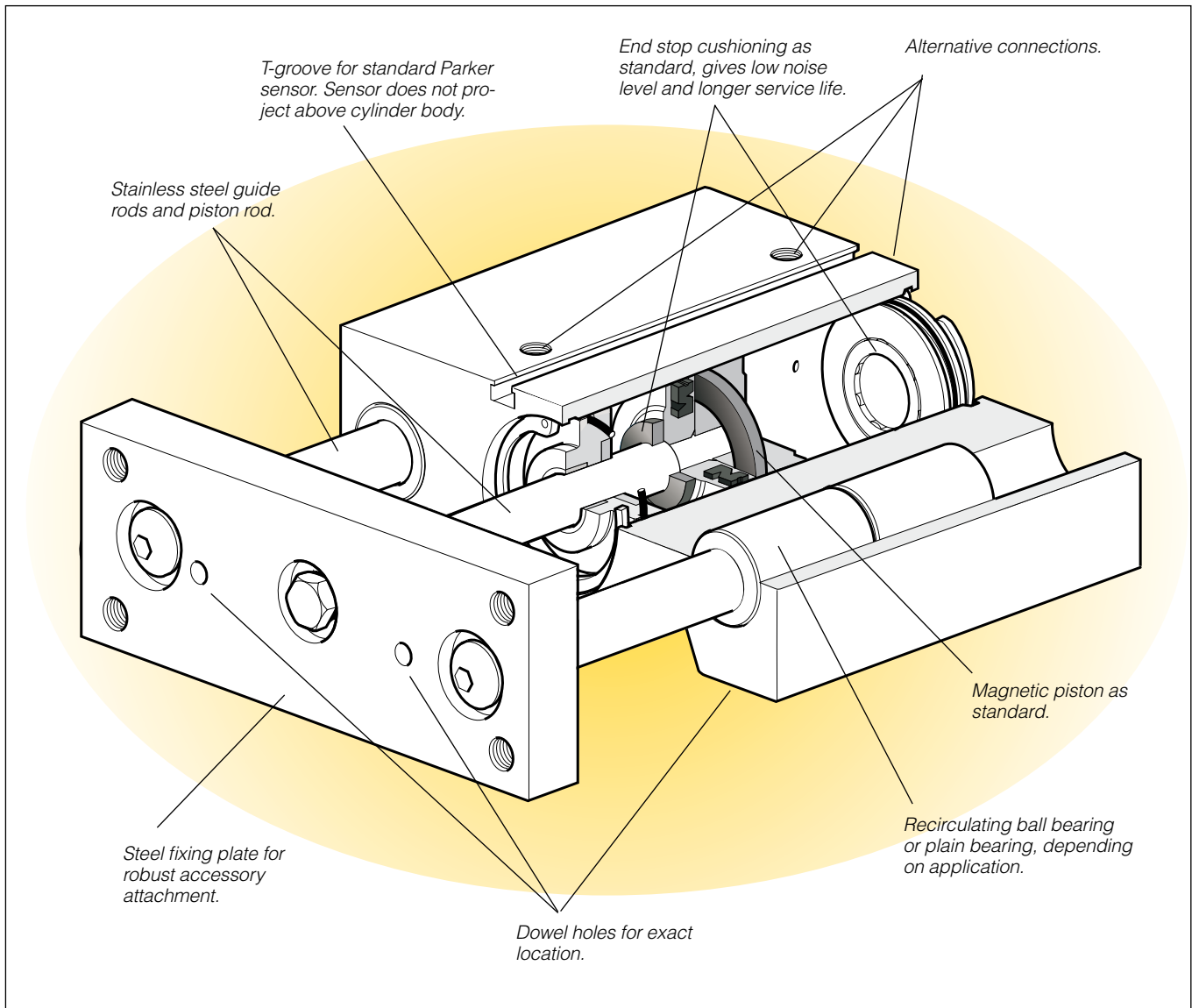

## P5T Cylinder

P5T cylinders are a modern and versatile range of cylinders with integral guides. The cylinders are double-acting, with end stop cushioning for quiet and vibration-free operation. They have strong shafts to prevent twisting, and everything is integrated into the cylinder housing.

The complete programme of cylinders comprises 9 cylinder diameters, Ø16 - Ø100 mm and strokes ranging from 10 to 200 mm. As with other Parker cylinders, the cylinder is initially lubricated with a white, non-poisonous grease which is approved for use in foodstuff preparation (USDA).

The strong guide shafts make it possible to absorb considerable thrust forces and torque. The cylinder is available with two different types of bearing in contact with the shaft, a recirculating ball bearing or plain bearing.

Multiple choice of connections is also a feature, one version has two connections at the rear or two connections from above, selectable by moving the enclosed plugs, and another version with two side connections is also available.

The P5T range has an integrated T-groove for sensors in the body. The T-groove makes it quick and easy to install non-contact sensors without increasing the installation dimensions of the cylinders.

The attachment plate and cylinder housing have dowel holes to give exact location during assembly. This also facilitates cylinder replacement.

The surface-treated steel fixing plate provides robust attachment.

## Fixed end stop cushioning

Polyurethane end stop cushioning built in to the end covers is standard

## Clean external design

The cylinder is designed without pockets or other cutouts in the body, in which dirt or fluids could collect. This makes cleaning both simple and easy.

## Non-contact sensing

All cylinders are supplied with a magnetic piston as standard, for non-contact sensing. Electronic type sensors and reed switches are available. They are supplied with either flying lead or cable plug connector.

## Options

In addition to the standard designs, a number of variants of the P5T range are available to special order, to provide effective solutions in a large number of applications.

Cylinders with special strokes

Cylinders with two fixing plates

Cylinders with adjustable stops, with cushioning

High-temperature cylinders for the temperature range of -10°C to +150°C (not magnetic piston).

## Plain bearing or recirculating ball bearings

The P5T is supplied with plain bearings as standard. This type of bearing has guide rods of greater diameter, providing excellent support for heavy loads, especially static loads. Plain bearings are highly tolerant of vibration and dirt, and are suitable for regular cleaning.

Recirculating ball bearings are used for applications which require high precision and low friction.

The choice should be based on the following factors:

Application requirements	Plain bearing	Recirculating ball bearings
Precision	Good	Excellent
Friction	Higher	Low
Coefficient of friction	Variable	Constant
Precision during service life	Variable	Constant
Static load capacity	Excellent	Good
Dynamic load capacity	Good, but with friction losses	Good
Vibration tolerance	Excellent	Average
Dirt tolerance	Excellent	Poor
Washing tolerance	Excellent	Poor

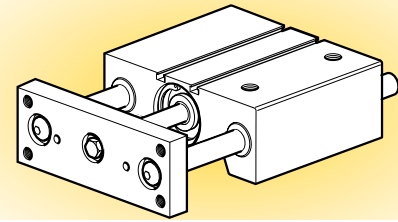

Double acting, connections on top.

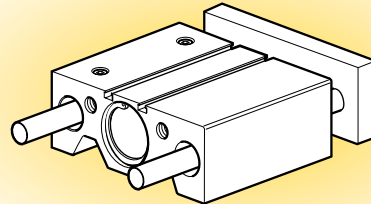

Double acting, connections at rear.

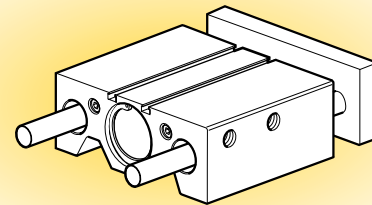

Double acting, connections on side.

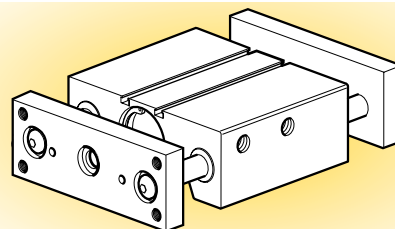

Double acting with two fixing plates, side connections are recommended.

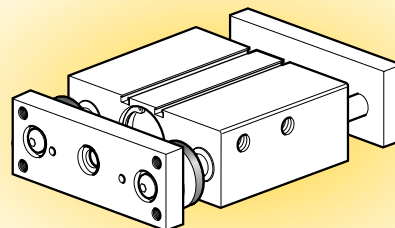

Double acting with two fixing plates and adjustable end stops with cushioning, side connections are recommended.

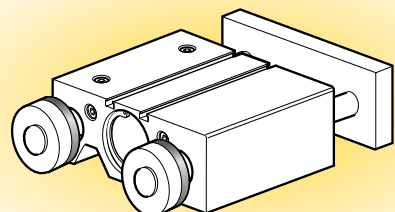

Double acting with one fixing plate adjustable end stops with cushioning, connections on side, on top or at rear.

## Cylinder forces, double acting variants

Cyl. bore/ pist. rod mm	Stroke	Piston area		Max theoretical force in N (bar)									
		cm <sup>2</sup>		1,0	2,0	3,0	4,0	5,0	6,0	7,0	8,0	9,0	10,0
<b>16/8</b>	+	2,0	20	40	60	80	100	<b>120</b>	141	161	181	201	
	-	1,5	15	30	45	60	75	<b>90</b>	106	121	136	151	
<b>20/10</b>	+	3,1	31	63	94	126	157	<b>188</b>	220	251	283	314	
	-	2,3	23	46	69	92	115	<b>138</b>	161	184	207	231	
<b>25/10</b>	+	4,9	49	98	147	196	245	<b>295</b>	344	393	442	491	
	-	4,1	41	82	124	165	206	<b>247</b>	289	330	371	412	
<b>32/16</b>	+	7,9	79	158	237	316	394	<b>473</b>	552	631	710	789	
	-	5,9	59	118	178	237	296	<b>355</b>	418	473	533	592	
<b>40/16</b>	+	12,6	126	251	377	503	628	<b>754</b>	880	1005	1131	1257	
	-	10,6	106	211	317	422	528	<b>633</b>	739	844	950	1056	
<b>50/20</b>	+	19,6	196	393	589	785	982	<b>1178</b>	1374	1571	1767	1963	
	-	16,5	165	330	495	660	825	<b>990</b>	1155	1319	1484	1649	
<b>63/20</b>	+	31,2	312	623	935	1247	1559	<b>1870</b>	2182	2494	2806	3117	
	-	28,0	280	561	841	1121	1402	<b>1682</b>	1962	2242	2523	2803	
<b>80/25</b>	+	50,3	503	1005	1508	2011	2513	<b>3016</b>	3519	4021	4524	5027	
	-	45,4	454	907	1361	1814	2268	<b>2721</b>	3175	3629	4082	4536	
<b>100/25</b>	+	78,5	785	1571	2356	3142	3927	<b>4712</b>	5498	6283	7069	7854	
	-	73,6	736	1473	2209	2945	3682	<b>4418</b>	5154	5890	6627	7363	

+ = Outward stroke  
- = Return stroke

### Note!

Select a theoretical force 50-100% larger than the force required

## Working medium, air quality

Working medium Dry, filtered compressed air to ISO 8573-1 class 3.4.3.

### Recommended air quality for cylinders

For best possible service life and trouble-free operation, ISO 8573-1 quality class 3.4.3 should be used. This means 5 µm filter (standard filter) dew point +3 °C for indoor operation (a lower dew point should be selected for outdoor operation) and oil concentration 1.0 mg oil/m<sup>3</sup>, which is what a standard compressor with a standard filter gives.

### ISO 8573-1 quality classes

Quality class	Pollution		Water max. press. dew point (°C)	Oil max concentration (mg/m <sup>3</sup> )
	particle size (µm)	max concentration (mg/m <sup>3</sup> )		
<b>1</b>	0,1	0,1	-70	0,01
<b>2</b>	1	1	-40	0,1
<b>3</b>	5	5	-20	1,0
<b>4</b>	15	8	+3	5,0
<b>5</b>	40	10	+7	25
<b>6</b>	-	-	+10	-

## Main data: P5T

Cylinder designation	Cylinder		Piston rod		Theoretical cylinder thrust at 6 bar		Air consumption	Connection thread
	diam.	area	diam.	area	outward stroke	return stroke		
	mm	cm <sup>2</sup>	mm	cm <sup>2</sup>	N	N		
<b>P5T-016-G-XXX<sup>1)</sup></b>	16	2,0	8	0,5	120	90	0,026	M5
<b>P5T-020-G-XXX<sup>1)</sup></b>	20	3,1	10	0,8	188	138	0,040	G1/8
<b>P5T-025-G-XXX<sup>1)</sup></b>	25	4,9	10	0,8	295	247	0,063	G1/8
<b>P5T-032-G-XXX<sup>1)</sup></b>	32	8,0	16	2,0	482	363	0,105	G1/8
<b>P5T-040-G-XXX<sup>1)</sup></b>	40	12,6	16	2,0	754	633	0,162	G1/8
<b>P5T-050-G-XXX<sup>1)</sup></b>	50	19,6	20	3,1	1178	990	0,253	G1/4
<b>P5T-063-G-XXX<sup>1)</sup></b>	63	31,2	20	3,1	1870	1682	0,414	G1/4
<b>P5T-080-G-XXX<sup>1)</sup></b>	80	50,3	25	4,9	3016	2721	0,669	G3/8
<b>P5T-100-G-XXX<sup>1)</sup></b>	100	78,5	25	4,9	4712	4418	1,043	G3/8

1) XXX = stroke

• = option, as in ordering key

2) Free air consumption for 10 mm stroke for a double stroke at 6 bar.

## Weights in kg

Cylinder diam. mm	Type of bearing	Shaft diam. mm	Standard stroke										
			10	25	40	50	75	100	125	150	175	200	
16	Plain bearing	10	0,35	0,43	0,51	0,57	0,70	0,84					
	Recirculating ball	8	0,32	0,39	0,46	0,51	0,64	0,76					
20	Plain bearing	12		0,76	0,86	0,94	1,11	1,29	1,47				
	Recirculating ball	10		0,70	0,80	0,86	1,03	1,19	1,36				
25	Plain bearing	16		1,13		1,39	1,65	1,91	2,17	2,43			
	Recirculating ball	12		0,98		1,20	1,43	1,65	1,88	2,11			
32	Plain bearing	20		1,67		2,07	2,46	2,86	3,26	3,65	4,05	4,45	
	Recirculating ball	16		1,51		1,86	2,21	2,56	2,91	3,27	3,62	3,97	
40	Plain bearing	20		2,00		2,42	2,84	3,26	3,68	4,10	4,52	4,84	
	Recirculating ball	16		1,82		2,20	2,57	2,95	3,32	3,70	4,08	4,45	
50	Plain bearing	25		2,63		3,22	3,81	4,40	4,99	5,59	6,18	6,77	
	Recirculating ball	20		2,35		2,87	3,39	3,92	4,44	4,96	5,48	6,01	
63	Plain bearing	25		3,29		3,98	4,66	5,34	6,02	6,71	7,39	8,07	
	Recirculating ball	20		2,99		3,60	4,22	4,83	5,45	6,06	6,67	7,29	
80	Plain bearing	30		6,06		7,12	8,18	9,24	10,30	11,36	12,42	13,48	
	Recirculating ball	25		5,66		6,63	7,61	8,58	9,56	10,53	11,51	12,49	
100	Plain bearing	35		10,69		12,03	13,37	14,71	16,05	17,39	18,73	20,08	
	Recirculating ball	30		10,16		11,40	12,64	13,89	15,13	16,37	17,61	18,85	

## Material specification

## Standard specification

Body	Natural anodised aluminium
End pieces	Black anodised aluminium
Piston rod	Stainless steel (SS 2346)
Guide rods	Stainless steel (SS 2346)
Plain bearing	PTFE / Steel
Ball bushing	Steel
Plate	Surface treated steel
Screws	Surface treated steel
Piston	Natural anodised aluminium
Magnetic ring	Rubber-bound magnetic material
Cushioning rings	Polyurethane
Piston seal	Nitrile rubber, NBR
O-rings	Nitrile rubber, NBR
Piston bearing	UHMWPE plastic

## Material specification

## High temperature option

Seals	Fluorocarbon rubber, FPM
Piston bearing	Bronze filled PTFE

## Other data

Working medium	Dry, filtered air
Working pressure	max. 10 bar
Working temperature	max +80 °C min -20 °C
High temp. option	max +150 °C min -10 °C

**Guide for selecting suitable tubing**

The selection of the correct size of tubing is often based on experience, with no great thought to optimizing energy efficiency and cylinder velocity. This is usually acceptable, but making a rough calculation can result in worthwhile economic gains.

**The following is the basic principle:**

1. The primary line to the working valve could be over sized (this does not cause any extra air consumption and consequently does not create any extra costs in operation).
2. The tubes between the valve and the cylinder should, however, be optimized according to the principle that an insufficient bore throttles the flow and thus limits the cylinder speed, while an oversized pipe creates a dead volume which increases the air consumption and filling time.

The chart below is intended to help when selecting the correct size of tube to use between the valve and the cylinder.

**The following prerequisites apply:**

The cylinder load should be about 50% of the theoretical force (= normal load). A lower load gives a higher velocity and vice versa. The tube size is selected as a function of the cylinder bore, the desired cylinder velocity and the tube length between the valve and the cylinder.

If you want to use the capacity of the valve to its maximum, and obtain maximum speed, the tubing should be chosen so that they at least correspond with the equivalent restriction diameter (see description below), so that the tubing does not restrict the total flow. This means that a short tubing must have at least the equivalent restriction diameter. If the tubing is longer, choose it from the table below. Straight fittings should be chosen for highest flow rates. (Elbow and banjo fittings cause restriction.)

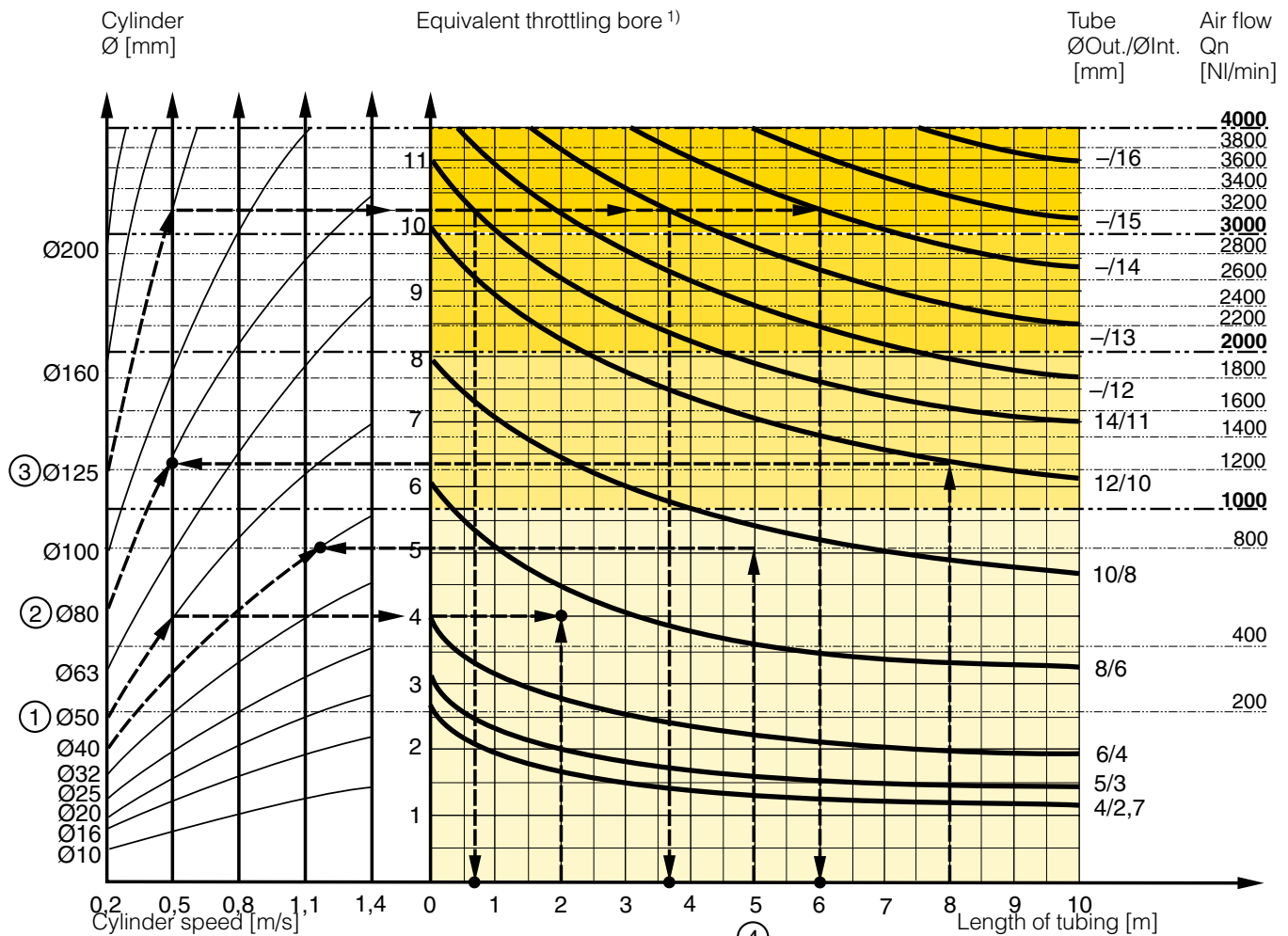

- 1) The “equivalent throttling bore” is a long throttle (for example a tube) or a series of throttles (for example, through a valve) converted to a short throttle which gives a corresponding flow rate. This should not be confused with the “orifice” which is sometimes specified for valves. The value for the orifice does not normally take account of the fact that the valve contains a number of throttles.
- 2) Qn is a measure of the valve flow capacity, with flow measured in litre per minute (l/min) at 6 bar(e) supply pressure and 1 bar pressure drop across the valve.



**Example ①: Which tube diameter should be used?**

A 50 mm bore cylinder is to be operated at 0.5 m/s. The tube length between the valve and cylinder is 2 m. In the diagram we follow the line from 50 mm bore to 0.5 m/s and get an “equivalent throttling bore” of approximately 4 mm. We continue out to the right in the chart and intersect the line for a 2 m tube between the curves for 4 mm (6/4 tube) and 6 mm (8/6 tube). This means that a 6/4 tube throttles the velocity somewhat, while an 8/6 tube is a little too large. We select the 8/6 tube to obtain full cylinder velocity.

**Example ②: What cylinder velocity will be obtained?**

A 80 mm bore cylinder will be used, connected by 8 m 12/10 tube to a P2L-B valve. What cylinder velocity will we get? We refer to the diagram and follow the line from 8 mm tube length up to the curve for 12/10 tube. From there, we go horizontally to the curve for the Ø80 cylinder. We find that the velocity will be about 0.5 m/s.

**Example ③: What is the minimum inner diameter and maximum length of tube?**

For an application a 125 mm bore cylinder will be used. Maximum velocity of piston rod is 0.5 m/s. The cylinder will be controlled by a P2L-D valve. What diameter of tube can be used and what is maximum length of tube. We refer to the diagram. We start at the left side of the diagram cylinder Ø125. We follow the line until the intersection with the velocity line of 0.5 m/s. From here we draw a horizontal line in the diagram. This line shows us we need an equivalent throttling bore of approximately 10 mm. Following this line horizontally we cross a few intersections. These intersections shows us the minimum inner diameter (rightside diagram) in combination with the maximum length of tube (bottomside diagram).

For example:

Intersection one: When a tube (14/11) will be used, the maximum length of tube is 0.7 meter.

Intersection two: When a tube (—/13) will be used, the maximum length of tube is 3.7 meter.

Intersection three: When a tube (—/14) will be used, the maximum length of tube is 6 meter.

**Example ④: Determining tube size and cylinder velocity with a particular cylinder and valve?**

For an application using a 40 mm bore cylinder with a valve with  $Q_n=800$  NI/min. The distance between the cylinder and valve has been set to 5 m.

**Tube dimension:** What tube bore should be selected to obtain the maximum cylinder velocity? Start at pipe length 5 m, follow the line up to the intersection with 800 NI/min. Select the next largest tube diameter, in this case Ø10/8 mm.

**Cylinder velocity:** What maximum cylinder velocity will be obtained? Follow the line for 800 NI/min to the left until it intersects with the line for the Ø40 mm cylinder. In this example, the speed is just above 1.1 m/s.

**Valve series with respective flows in NI/minute**

Valve series	Qn in NI/Min
Valvetronic Solstar	33
Interface PS1	100
Adex A05	173
Moduflex size 1, (2 x 3/2)	220
Valvetronic PVL-B 5/3 closed centre, 6 mm push in	290
Moduflex size 1, (4/2)	320
B43 Manual and mechanical	340
Valvetronic PVL-B 2 x 2/3, 6 mm push in	350
Valvetronic PVL-B 5/3 closed centre, G1/8	370
Compact Isomax DX02	385
Valvetronic PVL-B 2 x 3/2 G1/8	440
Valvetronic PVL-B 5/2, 6 mm push in	450
Valvetronic PVL-B 5/3 vented centre, 6 mm push in	450
Moduflex size 2, (2 x 3/2)	450
Flowstar P2V-A	520
Valvetronic PVL-B 5/3 vented centre, G1/8	540
Valvetronic PVL-B 5/2, G1/8	540
Valvetronic PVL-C 2 x 3/2, 8 mm push in	540
Adex A12	560
Valvetronic PVL-C 2 x 3/2 G1/8	570
Compact Isomax DX01	585
VIKING Xtreme P2LAX	660
Valvetronic PVL-C 5/3 closed centre, 8 mm push in	700
Valvetronic PVL-C 5/3 vented centre, G1/4	700
B3-Series	780
Valvetronic PVL-C 5/3 closed centre, G1/4	780
Moduflex size 2, (4/2)	800
Valvetronic PVL-C 5/2, 8 mm push in	840
Valvetronic PVL-C 5/3 vented centre, 8 mm push in	840
Valvetronic PVL-C 5/2, G1/4	840
Flowstar P2V-B	1090
ISOMAX DX1	1150
B53 Manual and mechanical	1160
B4-Series	1170
VIKING Xtreme P2L BX	1290
B5-Series, G1/4	1440
Airline Isolator Valve VE22/23	1470
ISOMAX DX2	2330
VIKING Xtreme P2LCX, G3/8	2460
VIKING Xtreme P2LDX, G1/2	2660
ISOMAX DX3	4050
Airline Isolator Valve VE42/43	5520
Airline Isolator Valve VE82/83	13680

## Dimensions, P5T basic cylinder

Connection option **D**  
(connection from above or rear)

## CAD drawings on the Internet

Our home page [www.parker.com/euro\\_pneumatic](http://www.parker.com/euro_pneumatic) includes the AirCad Drawing Library with 2D and 3D drawings for the main versions.

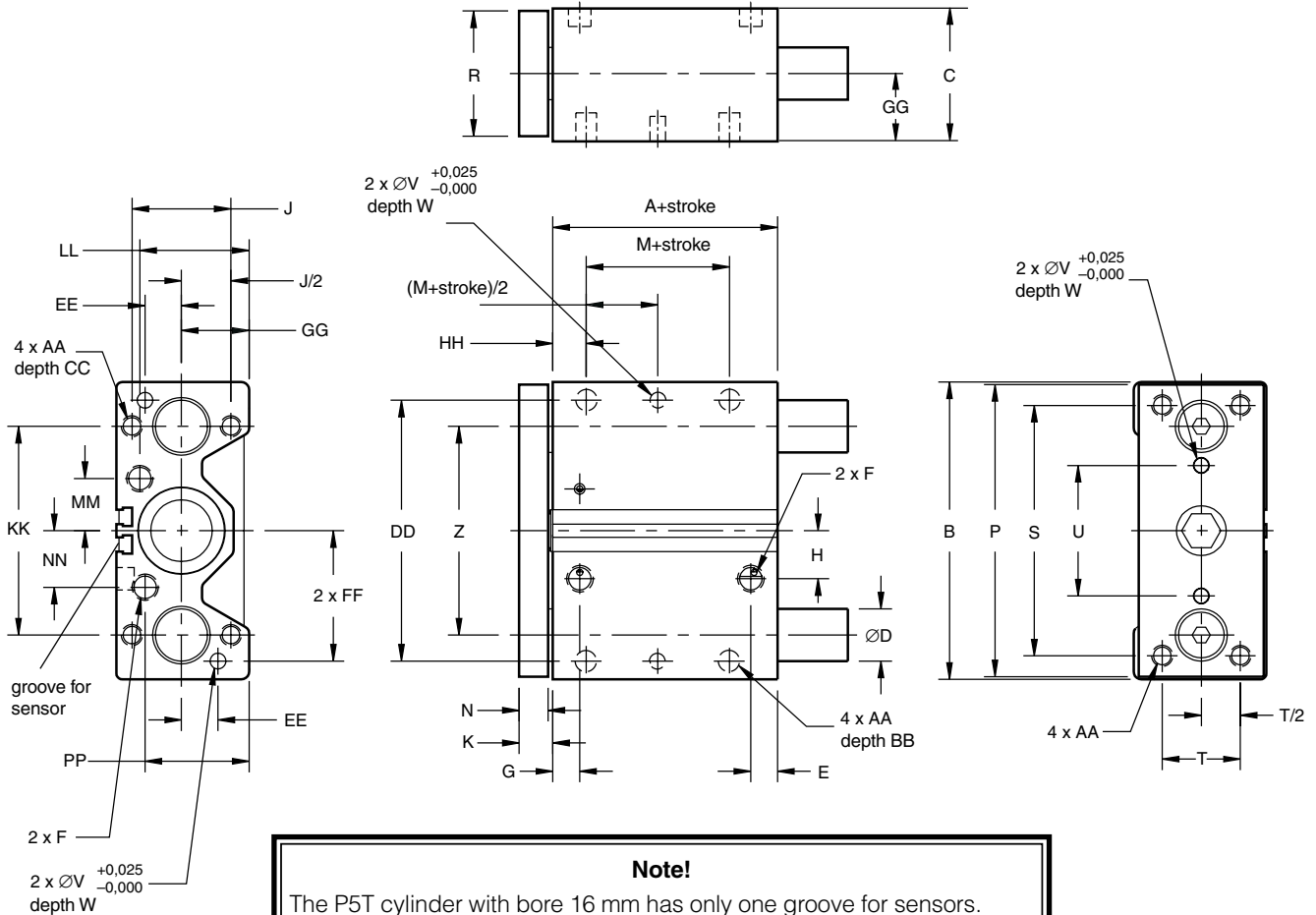

**Note!**

The P5T cylinder with bore 16 mm has only one groove for sensors.  
When 2 sensors are used for stroke 25 mm or shorter, sensors with 90 degree cable outlet has to be used, see page 23.

Cylinder diam. mm	A mm	B mm	C mm	D1*) mm	D2*) mm	E mm	F mm	G mm	H mm	J mm	K mm	M mm	N mm	P mm	R mm	S mm	T mm	U mm	V mm
16	37,8	64	31	8	10	10,1	M5	10,1	7	22	9,9	7	7,9	62	25,4	52	16	20	3
20	35	74	36	10	12	19	G1/8	10	15,8	26	9,9	10	7,9	72	31,8	60	18	30	4
25	38	88	42	12	16	21	G1/8	11,4	15,5	32	9,9	10	7,9	86	38	70	26	34	4
32	36	114	51	16	20	10,3	G1/8	10,4	18,4	38	13,1	5	11,1	112	44,5	96	30	50	6
40	44	124	51	16	20	12,1	G1/8	14,9	22,5	38	13,1	10	11,1	122	44	106	30	60	6
50	44,9	140	62	20	25	14,5	G1/4	16,1	27	44	14,7	10	12,7	138	57	120	40	60	8
63	50,1	150	75	20	25	16,4	G1/4	14,5	33	44	14,7	10	12,7	148	70	130	50	72	8
80	59,5	188	95	25	30	17,5	G3/8	19	37	56	18	15	16	185	88,9	160	60	92	10
100	66**)	224	115	30	35	21,9**)	G3/8	23	40	62	18	15	16	221	108	190	80	114	10

Cylinder diam. mm	W mm	Z mm	AA mm	BB mm	CC mm	DD mm	EE mm	FF mm	GG mm	HH mm	KK mm	LL mm	MM mm	NN mm	PP mm	Piston rod Ø mm
16	6	42	M5x0,8	7,5	10	54	8	27	15	13,1	42	22,5	11,3	9,7	23	8
20	6	52	M5x0,8	7,5	10	64	10	32	17	13,1	52	26	15,4	15,4	26	10
25	6	62	M6x1,0	10	12	76	11	38	21	14,1	62	33,4	17	17	33,4	10
32	6	80	M8x1,25	11	16	100	14	50	26	12,9	80	42	20	21,7	38	16
40	6	90	M8x1,25	11	16	110	14	55	26	13,9	90	41	24	26,4	37,9	16
50	8	100	M10x1,5	12	20	124	16	62	30	14,3	100	51	29	33	44	20
63	8	110	M10x1,5	15	20	132	18	66	36,5	16,3	110	62	36	37,8	57,8	20
80	10	140	M12x1,75	18	24	166	22	83	46,5	21	140	78	45	48	75,5	25
100	10	170	M14x2,0	21	28	200	24	100	56,5	25	170	91,5	53	51	95,5	25

Length tolerance ± 1 mm  
Stroke tolerance + 1.5/0 mm  
\*\*) Stroke 25 mm, A=75 mm, E=28 mm

\*) D1 = bearing rod diameter for recirculating ball bearing  
\*) D2 = bearing rod diameter for plain bearing

## Dimensions, P5T basic cylinder

Standard lengths

Cylinder diam mm	Stroke mm	L mm
<b>16</b>	10	36,2
	25, 40, 50, 75	60,2
	100	75,2
<b>20</b>	25, 40, 50, 75	66,9
	100, 125	91,9
<b>25</b>	25, 50, 75, 100	69,9
	125, 150	91,9
<b>32</b>	25, 50, 75, 100	77,9
	125, 150, 175, 200	116,0
<b>40</b>	25, 50, 75, 100	77,9
	125, 150, 175, 200	116,0
<b>50</b>	25, 50, 75, 100	84,0
	125, 150, 175, 200	124,1
<b>63</b>	25, 50, 75, 100	84,0
	125, 150, 175, 200	124,1
<b>80</b>	25, 50, 75, 100	101,8
	125, 150, 175, 200	140,0
<b>100</b>	25	122,8
	50, 75, 100	120,3
	125, 150, 175, 200	158,4

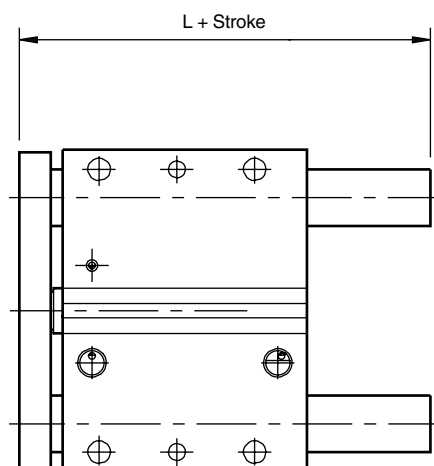

## Dimensions, P5T basic cylinder

Connection option **S** (side connections)

Cylinder diam. mm	SS mm	TT mm	UU mm	F mm
<b>16</b>	24,1	10	20	M5
<b>20</b>	29,2	10	20	M5
<b>25</b>	35,2	11,4	25	M5
<b>32</b>	41,7	10,4	34	G1/8
<b>40</b>	41,7	14,9	34	G1/8
<b>50</b>	51,3	16,1	38	G1/4
<b>63</b>	60,7	15,6	41,8	G1/4
<b>80</b>	75,5	19	47	G3/8
<b>100</b>	83,7	23	53,3	G3/8

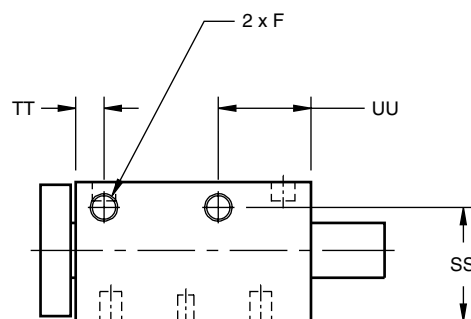

## Dimensions, P5T basic cylinder

Option **D**

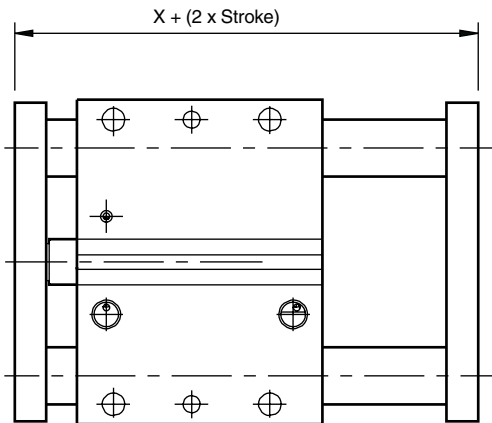

**Please note that load capacity increases with two fixing plates, due to greater bearing distance.**

## Dimensions, P5T with two fixing plates and adjustable end stop with cushioning

Option **A**

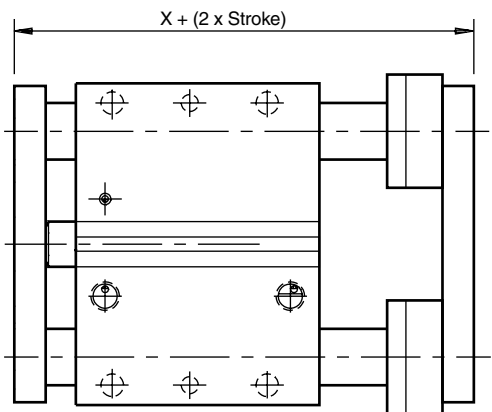

Cylinder diam. mm	Guide rod dia, mm	X for option			QQ mm	RR mm	XX mm
		D mm	A mm	E mm			
<b>16</b>	8	57,6	70,6	62,7	18,0	13,0	0
	10	57,6	70,6	62,7	24,0	13,0	1
<b>20</b>	10	54,9	67,9	59,9	24,0	13,0	1
	12	54,9	72,6	64,6	28,0	17,7	3
<b>25</b>	12	57,8	75,5	67,6	28,0	17,7	1
	16	57,8	77,5	69,6	34,0	19,7	4
<b>32</b>	16	62,2	81,9	70,8	34,0	19,7	0
	20	62,2	83,9	72,8	41,4	21,7	3,7
<b>40</b>	16	70,2	89,9	78,8	34,0	19,7	0
	20	70,2	91,9	80,8	41,4	21,7	3,7
<b>50</b>	20	74,3	96,0	83,3	41,4	21,7	0,7
	25	74,3	96,0	83,3	50,8	21,7	5,4
<b>63</b>	20	79,5	101,2	88,5	41,4	21,7	0,7
	25	79,5	101,2	88,5	50,8	21,7	5,4
<b>80</b>	25	95,5	117,2	101,2	50,8	21,7	1,4
	30	95,5	117,2	101,2	60,5	21,7	6,3
<b>100</b>	30	102,0	123,7	107,7	60,5	21,7	3,3
	35	102,0	123,7	107,7	65,0	21,7	5,5

## Dimensions, P5T with adjustable end stop with cushioning

Option **E**

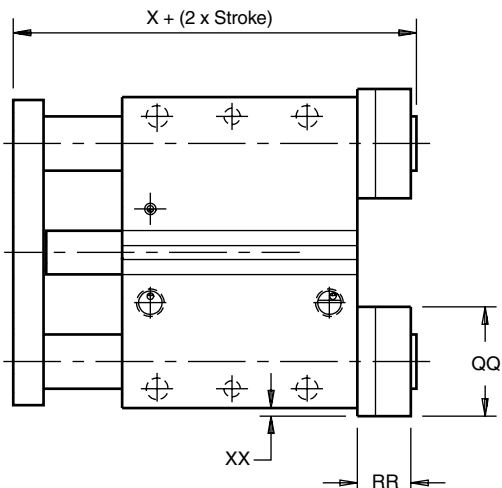

**Maximum load**

P5T cylinders can absorb the same load, irrespective of how it is installed. The loading diagram is based on a service life for the cylinder of at least 10 million cycles. At higher loadings, the service life will be reduced.

**Example**

Estimate the load limit for a P5T-16 with plain bearing and stroke + d = 75 mm has load capacity 50 N.

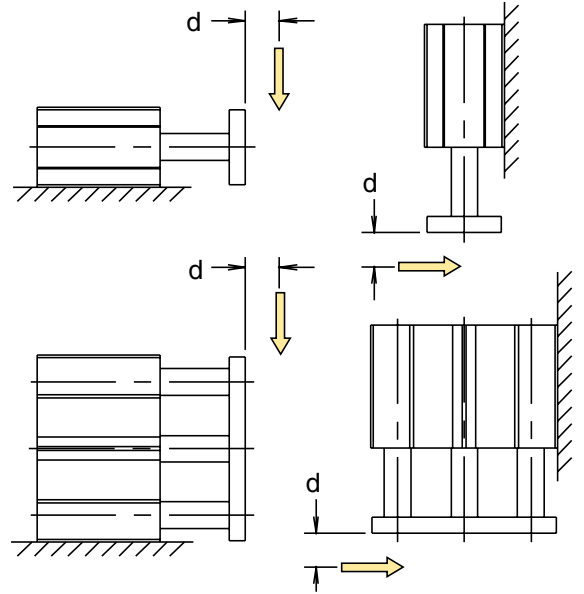

**Load capacity as a function of Stroke + d**

**Cylinder bore 16 mm**

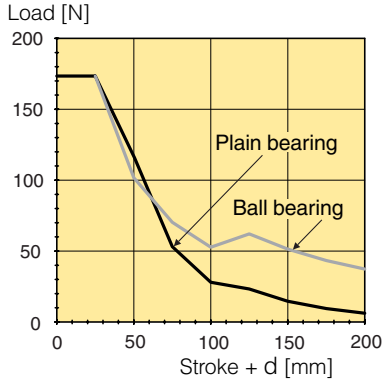

**Cylinder bore 20 mm**

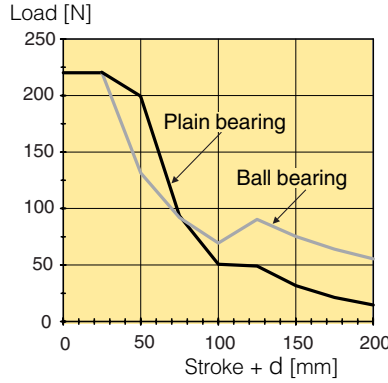

**Cylinder bore 25 mm**

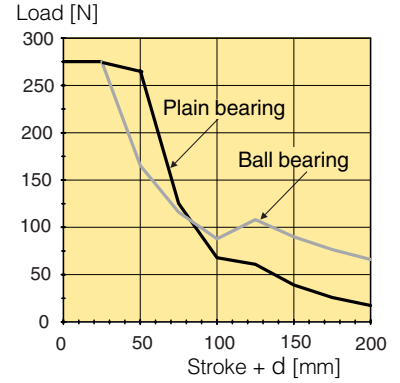

**Cylinder bore 32 mm**

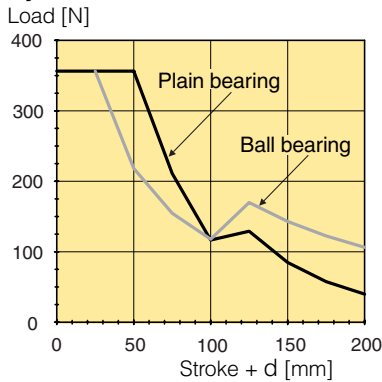

**Cylinder bore 40 mm**

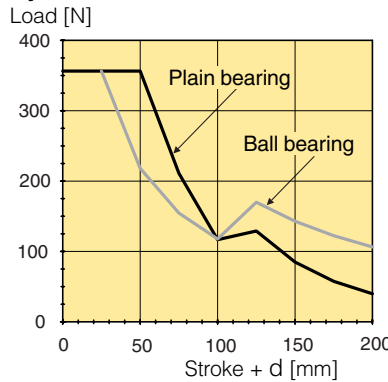

**Cylinder bore 50 mm**

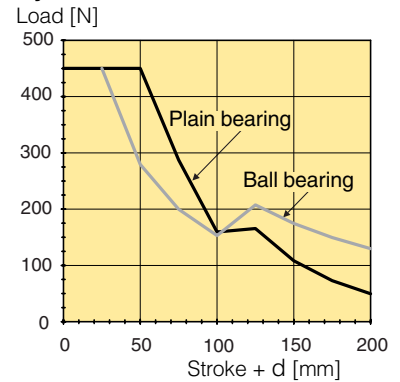

**Cylinder bore 63 mm**

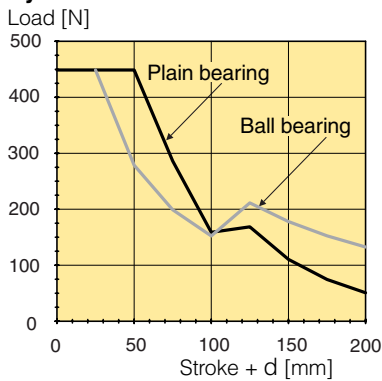

**Cylinder bore 80 mm**

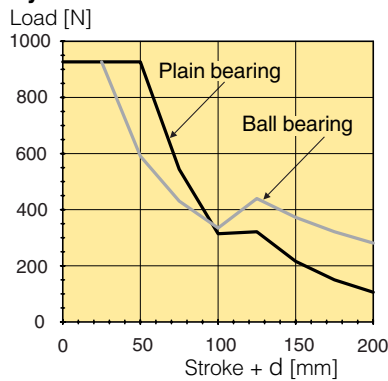

**Cylinder bore 100 mm**

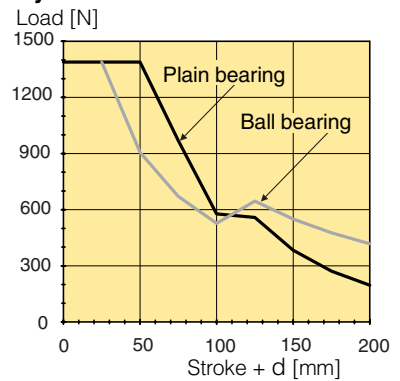

### Maximum Torsional Capacity for Symmetrical Torsion

When symmetrical loads are applied, P5T Series load ratings are greater than with asymmetrical loads because both pairs of shaft bearings equally resist the load.

**Example:**

A wrist rotate mechanism symmetrically grabs and rotates a part. The mechanism exerts a 20 Nm torque on a P5T-50 with 25mm stroke. The center of gravity for the wrist rotate mechanism is 25mm from the face of the P5T-50.

The "stroke + d" dimension equals 50mm (25 + 25). The P5T-50 with plain bearing will have adequate torsional capacity (22.5 Nm).

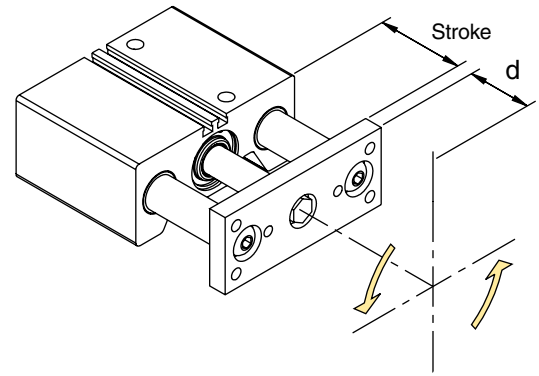

### Maximum torque as a function of Stroke + d

**Cylinder bore 16 mm**

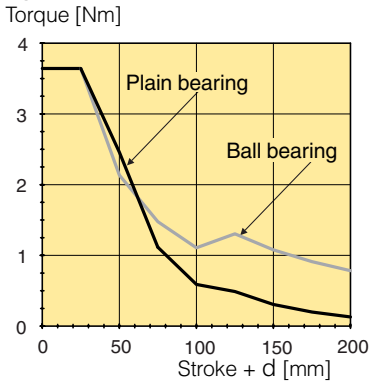

**Cylinder bore 20 mm**

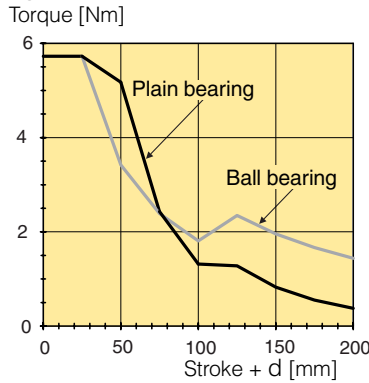

**Cylinder bore 25 mm**

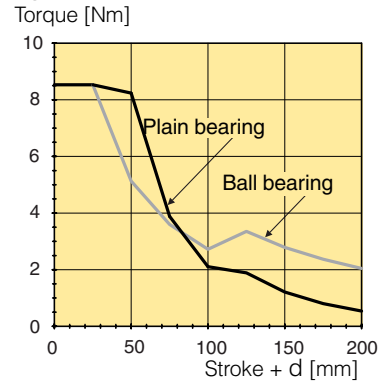

**Cylinder bore 32 mm**

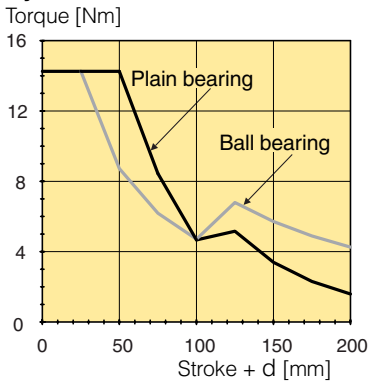

**Cylinder bore 40 mm**

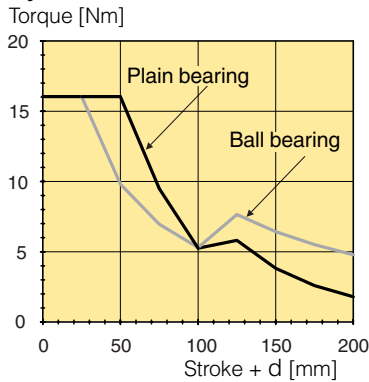

**Cylinder bore 50 mm**

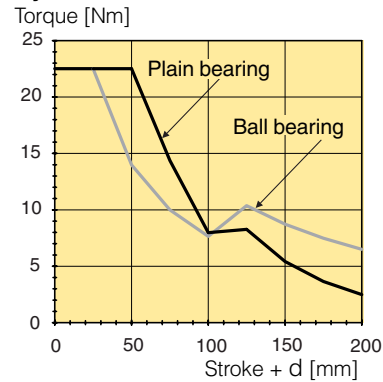

**Cylinder bore 63 mm**

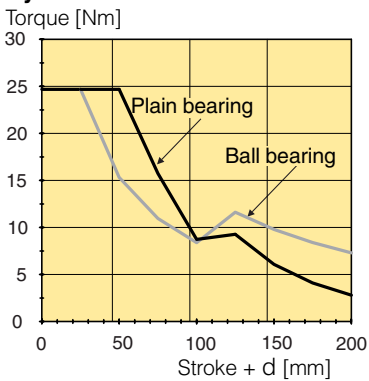

**Cylinder bore 80 mm**

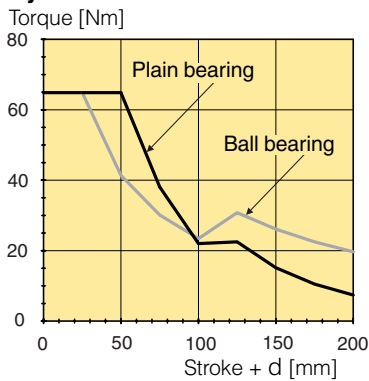

**Cylinder bore 100 mm**

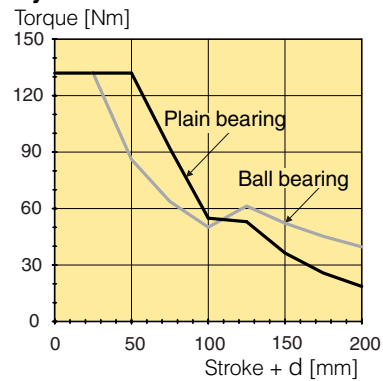

### Maximum Torsional Capacity for Asymmetrical Torque

Asymmetrical loading occurs when the load is applied to one side of the unit. P5T Series units can resist torsional loads that are asymmetrical according to the diagrams below.

**Example:**

A mechanism exerts an asymmetrical load of 15 Nm on a P5T-50 with 30 mm stroke. The centre of asymmetric torque  $d = 20$  mm. Stroke +  $d$  ( $30+20$ ) = 50 mm. The P5T-50 with plain bearing will have adequate torsional capacity (21 Nm).

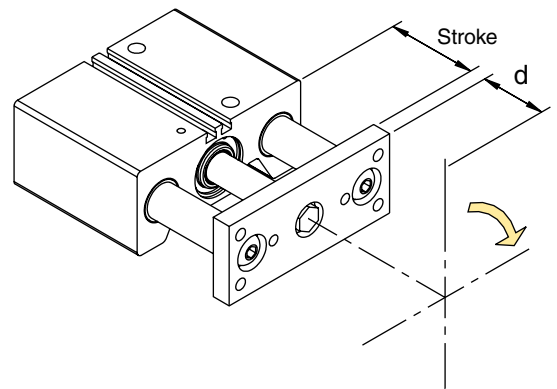

Maximum torque as a function of Stroke + d

**Cylinder bore 16 mm**

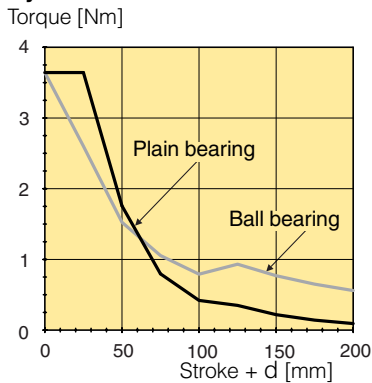

**Cylinder bore 20 mm**

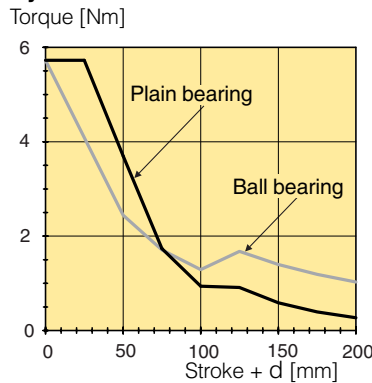

**Cylinder bore 25 mm**

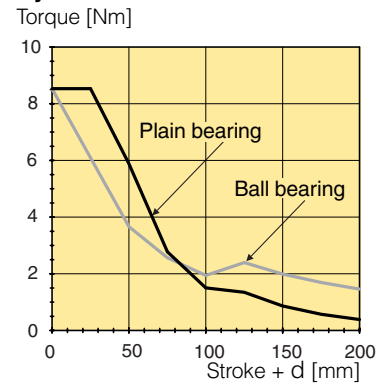

**Cylinder bore 32 mm**

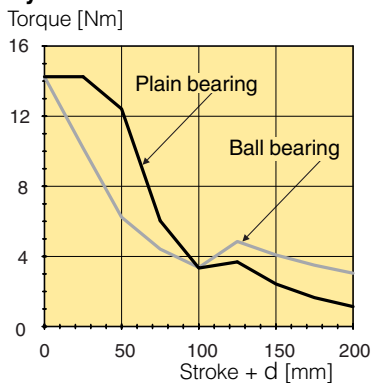

**Cylinder bore 40 mm**

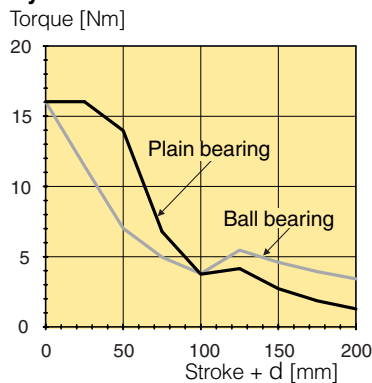

**Cylinder bore 50 mm**

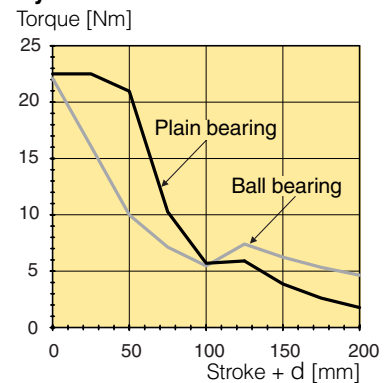

**Cylinder bore 63 mm**

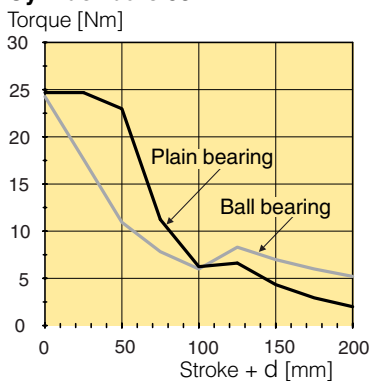

**Cylinder bore 80 mm**

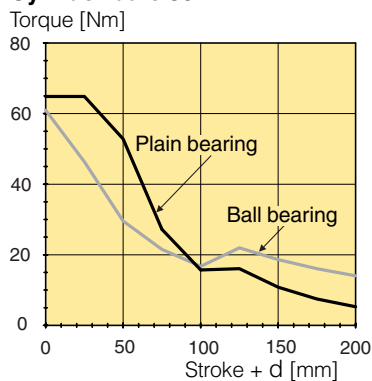

**Cylinder bore 100 mm**

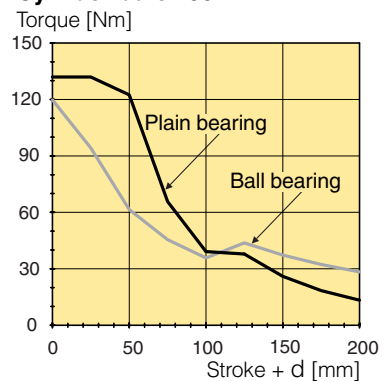

**Maximum load during vertical lift**

The P5T cylinder has the capacity to absorb eccentric load-ings irrespective of location.  
The load is assumed to be placed directly on the plate.

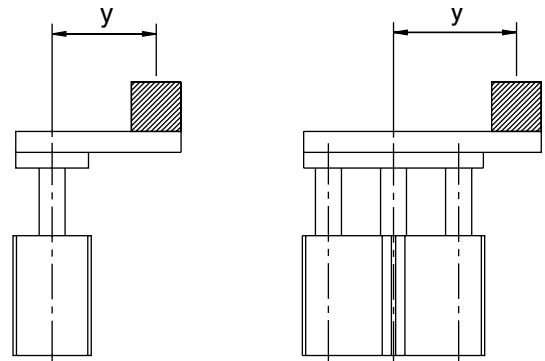

**Maximum vertical load as a function of eccentricity**

**Cylinder bore 16 mm**

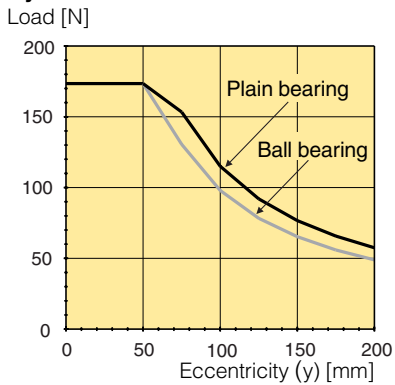

**Cylinder bore 20 mm**

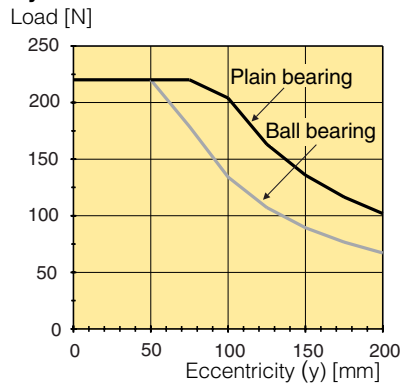

**Cylinder bore 25 mm**

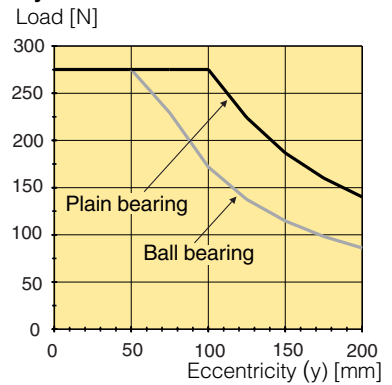

**Cylinder bore 32 mm**

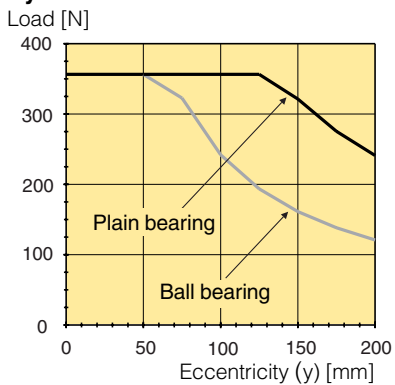

**Cylinder bore 40 mm**

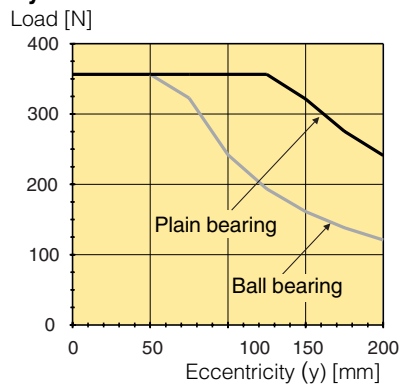

**Cylinder bore 50 mm**

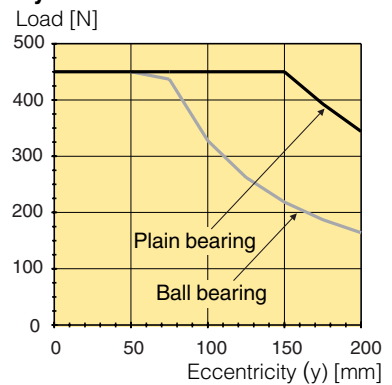

**Cylinder bore 63 mm**

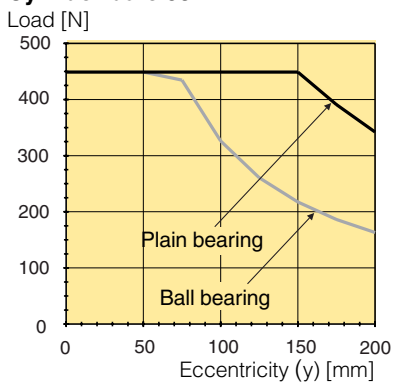

**Cylinder bore 80 mm**

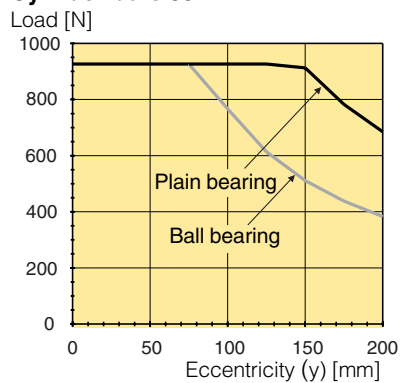

**Cylinder bore 100 mm**

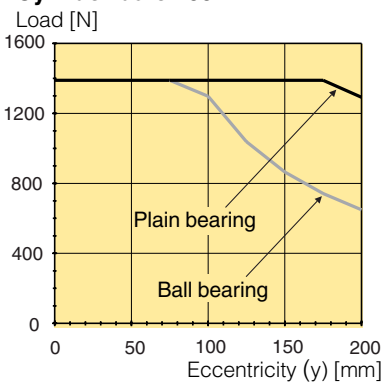



**Maximum loading as a stop cylinder**

The P5T cylinder can be used as a stop cylinder. It can be used both horizontally and vertically.

**NOTE! Cylinders with plain bearings are recommended for this type of application.**

**Example:**

A P5T-50 unit with a stroke up to 50 mm will stop an object moving at 0.5 m/s that weighs up to 50 kg.

**NOTE: The following graphs are based on 50mm of stroke.**

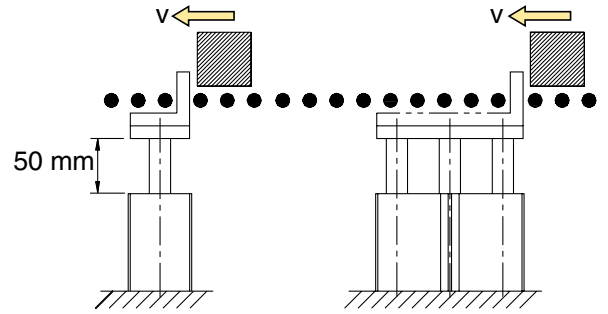

**Load stopping capacity as a function of speed**

**Cylinder bore 16 mm**

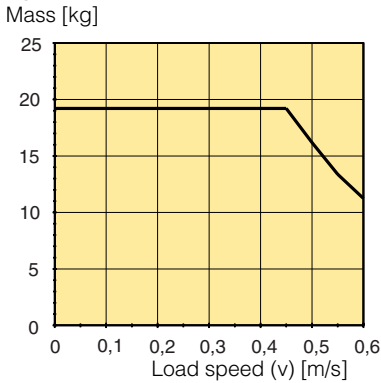

**Cylinder bore 20 mm**

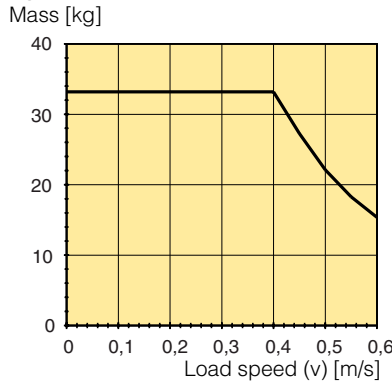

**Cylinder bore 25 mm**

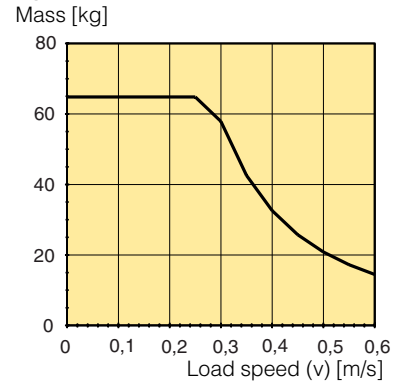

**Cylinder bore 32 mm**

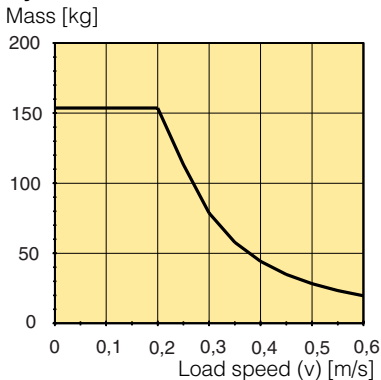

**Cylinder bore 40 mm**

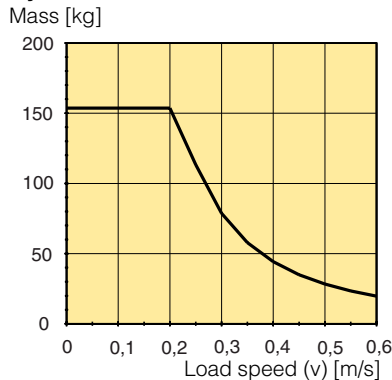

**Cylinder bore 50 mm**

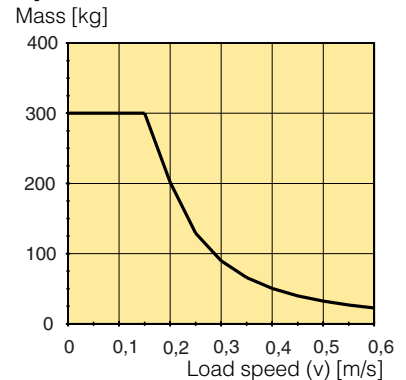

**Cylinder bore 63 mm**

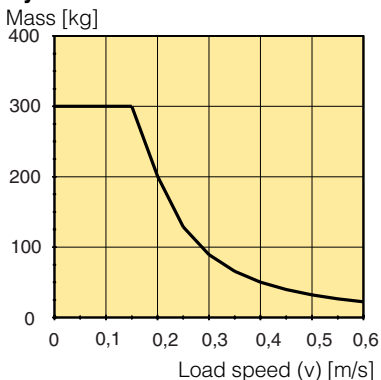

**Cylinder bore 80 mm**

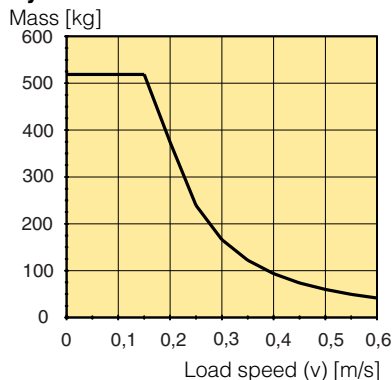

**Cylinder bore 100 mm**

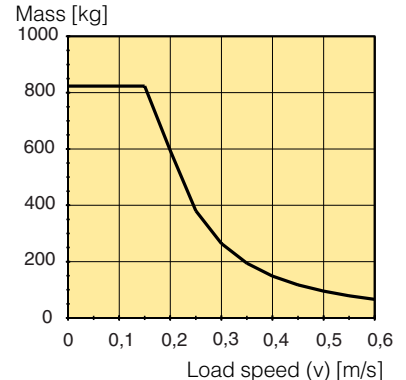

Ordering key

<b>P5T-</b>	<b>C</b>	<b>032</b>	<b>D</b>	<b>G</b>	<b>S</b>	<b>N</b>	<b>100</b>
<b>Bushing type</b>		<b>Cylinder Ø mm</b>	<b>Connection options</b>		<b>Option</b>		<b>Stroke in mm</b>
<b>C</b>	Plain bearing	<b>016</b>	<b>D</b>	Connection from above or rear, via movable plugs	<b>N</b>	None	e.g. 025 = 25 mm
<b>H</b>	Ball bearing	<b>020</b>	<b>S</b>	Connection from side	<b>E</b>	Adjustable stop with cushioning in extended position on the free bearing rods	Please refer to the table below for standard and maximum strokes.
		<b>025</b>	<b>Seals</b>		<b>D*</b>	Two fixing plates, one at each end of cylinder	
		<b>032</b>	<b>S</b>	Standard seals -20 °C to +80 °C	<b>A*</b>	E+D, i.e. two fixing plates and adjustable stop with cushioning in extended position (side connections recommended)	
		<b>040</b>	<b>F</b>	High temperature seals -10 °C to +150 °C			
		<b>050</b>					
		<b>063</b>					
		<b>080</b>					
		<b>100</b>					

\* Please note that the load capacity increases for the versions with two fixing plates, due to greater bearing distance.

Standard strokes

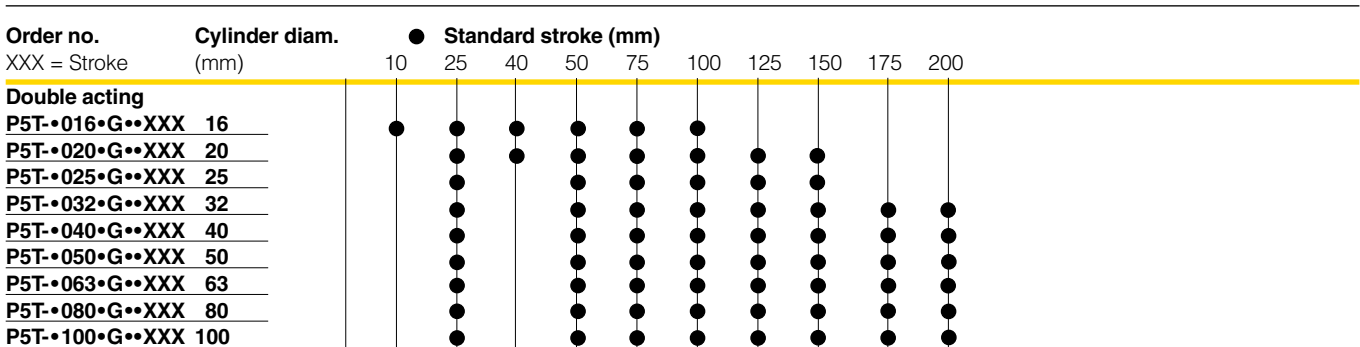

For cylinders with special stroke lengths, use the next longest standard stroke length with adjustable stop, option E. See the order key above and on page 12.

## Double acting P5T with plain bearing



Cyl. bore mm	Stroke mm	Order code
<b>16</b> M5 thread	10	P5T-C016DGSN010
	25	P5T-C016DGSN025
	40	P5T-C016DGSN040
	50	P5T-C016DGSN050
	75	P5T-C016DGSN075
	100	P5T-C016DGSN100
<b>20</b> G1/8 thread	25	P5T-C020DGSN025
	40	P5T-C020DGSN040
	50	P5T-C020DGSN050
	75	P5T-C020DGSN075
	100	P5T-C020DGSN100
	125	P5T-C020DGSN125
<b>25</b> G1/8 thread	25	P5T-C025DGSN025
	50	P5T-C025DGSN050
	75	P5T-C025DGSN075
	100	P5T-C025DGSN100
	125	P5T-C025DGSN125
	150	P5T-C025DGSN150
<b>32</b> G1/8 thread	25	P5T-C032DGSN025
	50	P5T-C032DGSN050
	75	P5T-C032DGSN075
	100	P5T-C032DGSN100
	125	P5T-C032DGSN125
	150	P5T-C032DGSN150
<b>40</b> G1/8 thread	25	P5T-C040DGSN025
	50	P5T-C040DGSN050
	75	P5T-C040DGSN075
	100	P5T-C040DGSN100
	125	P5T-C040DGSN125
	150	P5T-C040DGSN150
	175	P5T-C040DGSN175
	200	P5T-C040DGSN200

Cyl. bore mm	Stroke mm	Order code
<b>50</b> G1/4 thread	25	P5T-C050DGSN025
	50	P5T-C050DGSN050
	75	P5T-C050DGSN075
	100	P5T-C050DGSN100
	125	P5T-C050DGSN125
	150	P5T-C050DGSN150
	175	P5T-C050DGSN175
	200	P5T-C050DGSN200
<b>63</b> G1/4 thread	25	P5T-C063DGSN025
	50	P5T-C063DGSN050
	75	P5T-C063DGSN075
	100	P5T-C063DGSN100
	125	P5T-C063DGSN125
	150	P5T-C063DGSN150
	175	P5T-C063DGSN175
	200	P5T-C063DGSN200
<b>80</b> G3/8 thread	25	P5T-C080DGSN025
	50	P5T-C080DGSN050
	75	P5T-C080DGSN075
	100	P5T-C080DGSN100
	125	P5T-C080DGSN125
	150	P5T-C080DGSN150
	175	P5T-C080DGSN175
	200	P5T-C080DGSN200
<b>100</b> G3/8 thread	25	P5T-C100DGSN025
	50	P5T-C100DGSN050
	75	P5T-C100DGSN075
	100	P5T-C100DGSN100
	125	P5T-C100DGSN125
	150	P5T-C100DGSN150
	175	P5T-C100DGSN175
	200	P5T-C100DGSN200

**Note!**

The P5T cylinder with bore 16 mm has only one groove for sensors. When 2 sensors are used for stroke 25 mm or shorter, sensors with 90 degree cable outlet has to be used, see page 23.

## Our global series of sensors

This series of sensors is already being used or will be used in all future ranges in our global product programme involving cylinders/actuators. The sensors have small installation dimensions and either fit into the groove in the case profile or, as shown here, are fastened to the cylinder using a special attachment.

You can choose from electronic or reed sensors with a range of cable lengths fitted with 8 mm or M12 terminals.



## Electronic sensors

The new electronic sensors are "Solid State", i.e. they have no moving parts at all. They are provided with short-circuit protection and transient protection as standard. The built-in electronics make the sensors suitable for applications with high on and off switching frequency, and where very long service life is required.

### Technical data

Design	GMR (Giant Magnetic Resistance) magneto-resistive function
Installation	Sensor mounting P8S-TMC01
Outputs	PNP, normally open (also available in NPN design, normally closed, on request)
Voltage range	10-30 VDC 10-18 V DC, ATEX sensor
Ripple	max 10%
Voltage drop	max 2,5 V
Load current	max 100 mA
Internal consumption	max 10 mA
Actuating distance	min 9 mm
Hysteresis	max 1,5 mm
Repeatability accuracy	max 0,2 mm
On/off switching frequency	max 5 kHz
On switching time	max 2 ms
Off switching time	max 2 ms
Encapsulation	IP 67 (EN 60529)
Temperature range	-25 °C to +75 °C -20 °C to +45 °C, ATEX sensor
Indication	LED, yellow
Material housing	PA 12
Material screw	Stainless steel
Cable	PVC or PUR 3x0.25 mm <sup>2</sup> see order code respectively

## Reed sensors

The sensors are based on proven reed switches, which offer reliable function in many applications. Simple installation, a protected position on the cylinder and clear LED indication are important advantages of this range of sensors.

### Technical data

Design	Reed element
Mounting	Sensor mounting P8S-TMC01
Output	Normally open , or normally closed
Voltage range	10-30 V AC/DC or 10-120 V AC/DC 24-230 V AC/DC
Load current	max 500 mA for 10-30 V or max 100 mA for 10-120 V max 30 mA for 24-230 V
Breaking power (resistive)	max 6 W/VA
Actuating distance	min 9 mm
Hysteresis	max 1,5 mm
Repeatability accuracy	0,2 mm
On/off switching frequency	max 400 Hz
On switching time	max 1,5 ms
Off switching time	max 0,5 ms
Encapsulation	IP 67 (EN 60529)
Temperature range	-25 °C to +75 °C
Indication	LED, yellow
Material housing	PA12
Material screw	Stainless steel
Cable	PVC or PUR 3x0.14 mm <sup>2</sup> see order code respectively

## Electronic sensors

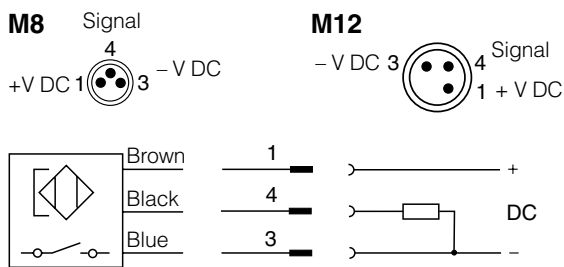

## Reed sensors

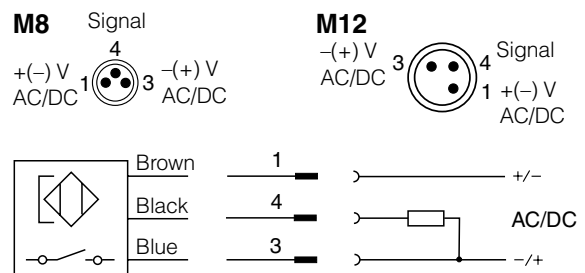

### P8S-GCFPX

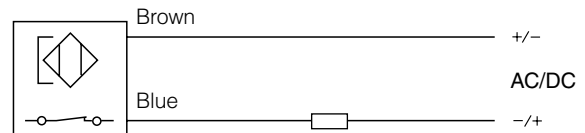

### P8S-GRFLX / P8S-GRFLX2

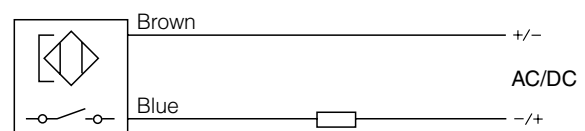

## Dimensions

### Sensors

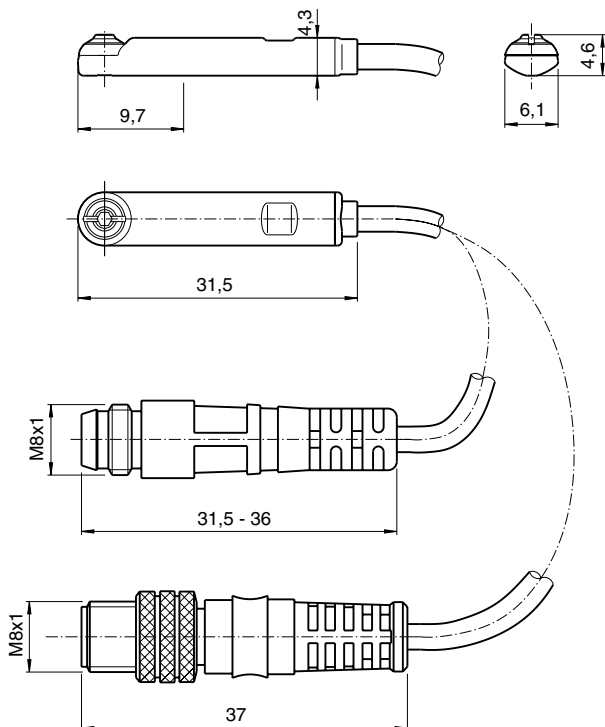

## Ordering data

Output/function	Cable/connector	Weight kg	Order code
<b>Electronic sensors , 10-30 V DC</b>			
PNP type, normally open	0,27 m PUR-cable and 8 mm snap-in male connector	0,007	<b>P8S-GPSHX</b>
PNP type, normally open	1,0 m PUR-cable and 8 mm snap-in male connector	0,013	<b>P8S-GPSCX</b>
PNP type, normally open	1,0 m PUR-cable and M8 screw male connector	0,013	<b>P8S-GPCCX</b>
PNP type, normally open	0,27 m PUR-cable and M12 screw male connector	0,015	<b>P8S-GPMHX</b>
PNP type, normally open	3 m PVC-cable without connector	0,030	<b>P8S-GPFLX</b>
PNP type, normally open	10 m PVC-cable without connector	0,110	<b>P8S-GPFTX</b>
<b>Electronic sensor 18-30 V DC</b>			
<b>ATEX-certified</b>			
 <b>II3G EEx nA II T4X</b> <b>II3D 135 °C IP67</b>			
Type PNP , normally open	3 m PVC-cable without connector	0,030	<b>P8S-GPFLX/EX</b>
<b>Reed sensors , 10-30 V AC/DC</b>			
Normally open	0,27 m PUR-cable and 8 mm snap-in male connector	0,007	<b>P8S-GSSHX</b>
Normally open	1,0 m PUR-cable and 8 mm snap-in male connector	0,013	<b>P8S-GSSCX</b>
Normally open	1,0 m PUR-cable and M8 male connector	0,013	<b>P8S-GSCCX</b>
Normally open	0,27 m PUR-cable and M12 screw male connector	0,015	<b>P8S-GSMHX</b>
Normally open	1,0 m PUR-cable and M12 screw male connector	0,023	<b>P8S-GSMCX</b>
Normally open	3 m PVC-cable without connector	0,030	<b>P8S-GSFLX</b>
Normally open	10 m PVC-cable without connector	0,110	<b>P8S-GSFTX</b>
Normally closed	5m PVC-cable without connector <sup>1)</sup>	0,050	<b>P8S-GCFPX</b>
<b>Reed sensors, 10-120 V AC/DC</b>			
Normally open	3 m PVC-cable without connector	0,030	<b>P8S-GRFLX</b>
<b>Reed sensorer, 24-230 V AC/DC</b>			
Normally open	3 m PVC-cable without connector	0,030	<b>P8S-GRFLX2</b>

1) Without LED

### Sensors for special applications

Sensors for applications where the short installation length and the 90 degree cable outlet are important factors. This type of sensor is an good alternative if a cylinder has a short stroke or tight installation.

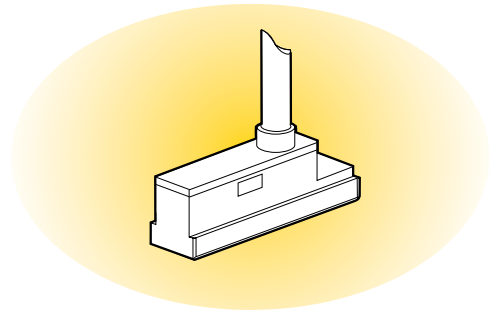

#### Reed switch sensors

The reed switch sensors incorporate a well-proven, universal-voltage, compact reed switch element, making them suitable for a wide range of applications. They can work with electronic control systems or conventional relay systems. No environment is too severe.

#### Technical data

Design	Reed
Output	Making
Voltage range	10 to 120 VAC/VDC
Max permissible ripple	10%
Max voltage drop	3 V
Max load current	100 mA
Max breaking power (resistive)	10 W
Min actuating distance	5 mm
Hysteresis	≤1,0 mm
Repeatability accuracy	≤0,2 mm
Max on/off switching frequency	400 Hz
Max on/off switching time	1 ms
Encapsulation	IP 67
Temperature range	-25 °C to +75 °C
Indication	LED, yellow
Shock resistance	30 g
Material, housing	PA 12
Material, mould	Epoxy
Cable	PVC 3x0,14 mm <sup>2</sup>
Cable incl. female part connector	PVC 3x0,14 mm <sup>2</sup>
Mounting	T slot

#### Electronic sensors

These sensors are of solid-state type, with no moving parts. Short-circuit and transient protection is incorporated as standard. The integral electronics make these sensors suitable for applications with very high switching frequencies.

#### Technical data

Design	Hall element
Output	PNP resp. NPN, N.O.
Voltage range	10-30 VDC
Max permissible ripple	10%
Max voltage drop	≤2 V
Max load current	150 mA
Max breaking power (resistive)	6 W
Internal consumption	15 mA
Min actuating distance	5 mm
Hysteresis	≤1,5 mm
Repeatability accuracy	≤0,2 mm
Max on/off switching frequency	50 Hz
P8S-SPELXD, SPETXD, SPTHXD	5 kHz
Others	5 kHz
Max on/off switching time	0,8/3,0 ms
Encapsulation	IP 67
Temperature range	-25 °C to +75 °C
Indication	LED, yellow
Shock resistance	30 g
Material, housing	PA 12
Material, mould	Epoxy
Cable	PVC 3x0,14 mm <sup>2</sup>
Cable incl. female part connector	PVC 3x0,14 mm <sup>2</sup>
Connector	Diam. 8 mm snap on
Mounting	T slot

#### Ordering data

Output	Cable connection	Cable length	Weight kg	Order code
<b>Reed sensors</b>				
making	90°	3,0 m	0,030	<b>P8S-SRELX</b>
making	90°	10,0 m	0,110	<b>P8S-SRETX</b>
making	90°	0,3 m*	0,005	<b>P8S-SRTHX</b>

\*) Cable shall be ordered separately.

#### Ordering data

Output	Cable connection	Cable length	Weight kg	Order code
<b>Electronic sensors</b>				
PNP, N.O.	90°	3,0 m	0,030	<b>P8S-SPELXD</b>
PNP, N.O.	90°	10,0 m	0,110	<b>P8S-SPETXD</b>
PNP, N.O.	90°	0,3 m*	0,005	<b>P8S-SPTHXD</b>

Dimensions

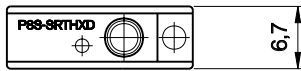
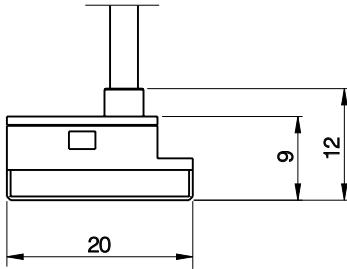
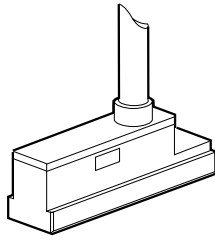

Reed sensor symbol

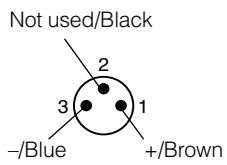
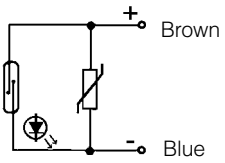

Electronic sensor symbol

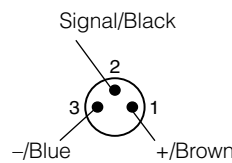
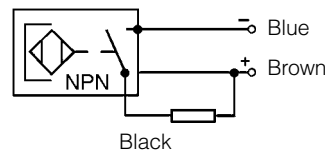
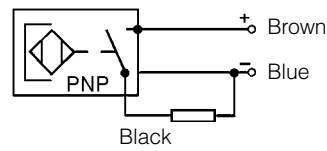



### Connecting cables with one connector

The cables have an integral snap-in female connector.



Type of cable	Cable/connector	Weight kg	Order code
<b>Cables for sensors, complete with one female connector</b>			
Cable, Flex PVC	3 m, 8 mm Snap-in connector	0,07	<b>9126344341</b>
Cable, Flex PVC	10 m, 8 mm Snap-in connector	0,21	<b>9126344342</b>
Cable, Super Flex PVC	3 m, 8 mm Snap-in connector	0,07	<b>9126344343</b>
Cable, Super Flex PVC	10 m, 8 mm Snap-in connector	0,21	<b>9126344344</b>
Cable, Polyurethane	3 m, 8 mm Snap-in connector	0,01	<b>9126344345</b>
Cable, Polyurethane	10 m, 8 mm Snap-in connector	0,20	<b>9126344346</b>
Cable, Polyurethane	5 m, M12 screw connector	0,07	<b>9126344348</b>
Cable, Polyurethane	10 m, M12 screw connector	0,20	<b>9126344349</b>

### Male connectors for connecting cables

Cable connectors for producing your own connecting cables. The connectors can be quickly attached to the cable without special tools. Only the outer sheath of the cable is removed. The connectors are available for M8 and M12 screw connectors and meet protection class IP 65.



Connector	Weight kg	Order code
M8 screw connector	0,017	<b>P8SCS0803J</b>
M12 screw connector	0,022	<b>P8SCS1204J</b>

### Ready to use connecting cables with connectors at each end

As accessories the system comprises a large number of different cables in order to meet all requirements that may arise and to make the installation simple, fast and reliable.

Cables with moulded 8 mm snap-in round contacts in both ends. The cables are available in two types, one with a straight male and female connectors respectively, and one with a straight 3-pole male connector in one end and an angled 3-pole female connector in the other end.



#### Technical data

##### Contacts

Moulded 8 mm snap-in male/female contacts.  
Enclosure IP67

##### Cable

Conductor 3x0,25 mm<sup>2</sup> (32x0,10 mm<sup>2</sup>)  
Sheath PVC/PUR  
Colour Black

Cables with straight 3-pole male and female connectors respectively.

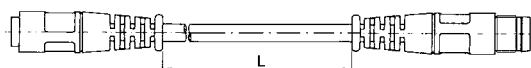

Cables with a straight 3-pole male connector in one end and an angled 3-pole female connector in the other end.

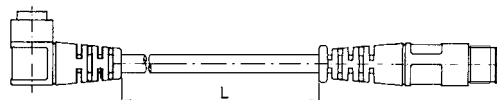

Designation	Weight kg	Order code	Designation	Weight kg	Order code
Cable with straight contacts, 0,2 m	0,02	<b>9121717014</b>	Cable with straight and angled connectors, 0,2 m	0,02	<b>9121717022</b>
Cable with straight contacts, 0,3 m	0,02	<b>9121717015</b>	Cable with straight and angled connectors, 0,3 m	0,02	<b>9121717023</b>
Cable with straight contacts, 0,5 m	0,03	<b>9121717016</b>	Cable with straight and angled connectors, 0,5 m	0,03	<b>9121717024</b>
Cable with straight contacts, 1,0 m	0,03	<b>9121717017</b>	Cable with straight and angled connectors, 1,0 m	0,03	<b>9121717025</b>
Cable with straight contacts, 2,0 m	0,05	<b>9121717018</b>	Cable with straight and angled connectors, 2,0 m	0,05	<b>9121717026</b>
Cable with straight contacts, 3,0 m	0,07	<b>9121717019</b>	Cable with straight and angled connectors, 3,0 m	0,07	<b>9121717027</b>
Cable with straight contacts, 5,0 m	0,12	<b>9121717020</b>	Cable with straight and angled connectors, 5,0 m	0,12	<b>9121717028</b>
Cable with straight contacts, 10 m	0,23	<b>9121717021</b>	Cable with straight and angled connectors, 10 m	0,23	<b>9121717029</b>

### Connection block Valvetronic 110

The Valvetronic 110 is a connection block that can be used for collecting signals from sensors at various points on a machine and connecting them to the control system via a multicore cable. Valvetronic 110 can also be used for central connection of the multi-core cable to the outputs of a control system, and can be laid to a machine where the output signals can be connected. The connection block has ten 8 mm snap-in circular connectors and a multi-core cable which is available in lengths of 3 or 10 m. The connections on the block are numbered from 1 to 10. Blanking plugs are available for unused connections, as labels for marking the connections of each block.



### Technical data

#### Connections:

Ten 3-pole numbered 8 mm round snap-in female contacts

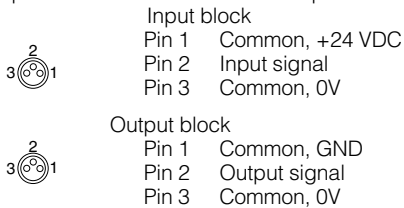

#### Electrical data:

Voltage 24 VDC (max. 60 V AC/75 V DC)  
 Insulation group according to DIN 0110 class C  
 Load max. 1 A per connection total max. 3 A

#### Cable:

Length 3 m or 10 m  
 Type of cable LifYY11Y  
 Conductor 12  
 Area 0.34 mm<sup>2</sup>  
 Colour marking According to DIN 47 100

#### Mechanical data

Enclosure IP 67, DIN 40050 with fitted contacts and/or blanking plugs.  
 Temperature -20 °C to +70 °C

#### Material

Body PA 6,6 VD according to UL 94  
 Contact holder PBTP  
 Snap-in ring LDPE  
 Moulding mass Epoxy  
 Seal NBR  
 Screws Plated steel

#### Industrial durability

Good chemical and oil resistance. Tests should be performed in aggressive environments.

### Ordering data

Designation	Weight kg	Order code
Connection block Valvetronic 110 with 3 m cable	0,32	<b>9121719001</b>
Connection block Valvetronic 110 with 10 m cable	0,95	<b>9121719002</b>
Blanking plugs (pack of 10) Use blanking plugs to close unused connections.	0,02	<b>9121719003</b>
Labels (pack of 10) White labels to insert in grooves on the side of the connection	0,02	<b>9121719004</b>

### Dimensions and wiring diagrams

Conductor Colour	Input	Output
1	Pink	Signal 1
2	Grey	Signal 2
3	Yellow	Signal 3
4	Green	Signal 4
5	White	Signal 5
6	Red	Signal 6
7	Black	Signal 7
8	Violet	Signal 8
9	Grey-Pink	Signal 9
10	Red-Blue	Signal 10
A	Blue	0 V
B	Brown	+24 V



Symbol which indicates sub-components in seal kit (for replacement during maintenance)

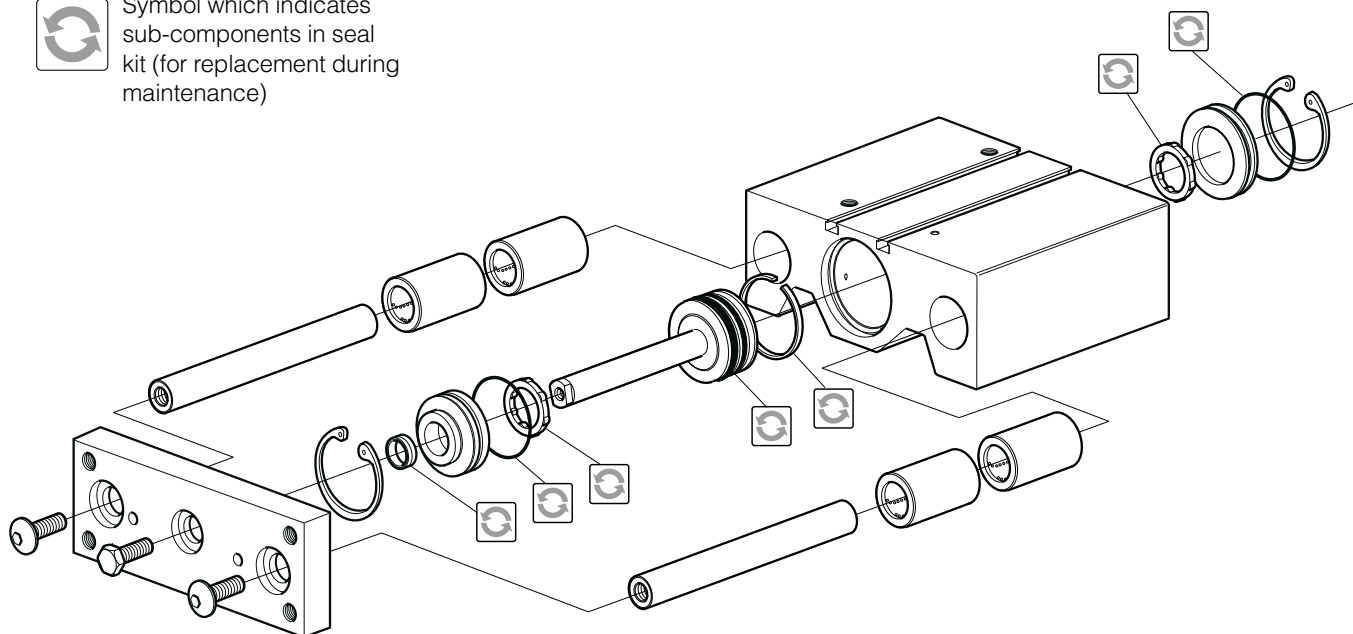

**Seal kits for P5T**

	Cylinder diam. mm	Standard temperature Nitrile rubber	High temperature Fluorocarbon rubber
	16	PSK-P5T16	PSK-P5T16F
	20	PSK-P5T20	PSK-P5T20F
	25	PSK-P5T25	PSK-P5T25F
	32	PSK-P5T32	PSK-P5T32F
	40	PSK-P5T40	PSK-P5T40F
	50	PSK-P5T50	PSK-P5T50F
	63	PSK-P5T63	PSK-P5T63F
	80	PSK-P5T80	PSK-P5T80F
	100	PSK-P5T100	PSK-P5T100F

**Grease for P5T**

	Weight	Standard temperature	High temperature
	30 g	9127394541	9127394521

# Sales Offices

**AE – United Arab Emirates,**  
Abu Dhabi  
Tel: +971 2 67 88 587

**AR – Argentina,** Buenos Aires  
Tel: +54 3327 44 4129

**AT – Austria,** Wiener Neustadt  
Tel: +43 (0)2622 23501-0

**AT – Austria,** Wiener Neustadt  
(Eastern Europe)  
Tel: +43 (0)2622 23501 970

**AU – Australia,** Castle Hill  
Tel: +61 (0)2-9634 7777

**AZ – Azerbaijan,** Baku  
Tel: +994 50 2233 458

**BE – Belgium,** Nivelles  
Tel: +32 (0)67 280 900

**BR – Brazil,** Cachoeirinha RS  
Tel: +55 51 3470 9144

**BY – Belarus,** Minsk  
Tel: +375 17 209 9399

**CA – Canada,** Milton, Ontario  
Tel: +1 905 693 3000

**CH – Switzerland**  
See Germany

**CN – China,** Shanghai  
Tel: +86 21 5031 2525

**CN – China,** Beijing  
Tel: +86 10 6561 0520

**CZ – Czech Republic,** Klecany  
Tel: +420 284 083 111

**DE – Germany,** Kaarst  
Tel: +49 (0)2131 4016 0

**DK – Denmark,** Ballerup  
Tel: +45 43 56 04 00

**ES – Spain,** Madrid  
Tel: +34 902 33 00 01

**FI – Finland,** Vantaa  
Tel: +358 (0)20 753 2500

**FR – France,**  
Contamine-sur-Arve  
Tel: +33 (0)4 50 25 80 25

**GR – Greece,** Athens  
Tel: +30 210 933 6450

**HK – Hong Kong**  
Tel: +852 2428 8008

**HU – Hungary,** Budapest  
Tel: +36 1 220 4155

**IE – Ireland,** Dublin  
Tel: +353 (0)1 466 6370

**IN – India,** Mumbai  
Tel: +91 22 6513 7081-85

**IT – Italy,** Corsico (MI)  
Tel: +39 02 45 19 21

**JP – Japan,** Fujisawa  
Tel: +(81) 4 6635 3050

**KR – South Korea,** Seoul  
Tel: +82 2 559 0400

**KZ – Kazakhstan,** Almaty  
Tel: +7 3272 505 800

**LV – Latvia,** Riga  
Tel: +371 74 52601

**MX – Mexico,** Apodaca  
Tel: +52 81 8156 6000

**MY – Malaysia,** Subang Jaya  
Tel: +60 3 5638 1476

**NL – The Netherlands,**  
Oldenzaal  
Tel: +31 (0)541 585 000

**NO – Norway,** Ski  
Tel: +47 64 91 10 00

**NZ – New Zealand,** Mt Wellington  
Tel: +64 9 574 1744

**PL – Poland,** Warsaw  
Tel: +48 (0)22 573 24 00

**PT – Portugal,** Leca  
da Palmeira  
Tel: +351 22 999 7360

**RO – Romania,** Bucharest  
Tel: +40 21 252 1382

**RU – Russia,** Moscow  
Tel: +7 495 645-2156

**SE – Sweden,** Spånga  
Tel: +46 (0)8 59 79 50 00

**SG – Singapore**  
Tel: +65 6887 6300

**SL – Slovenia,** Novo Mesto  
Tel: +386 7 337 6650

**SK – Slovakia**  
See Czech Republic

**TH – Thailand,** Bangkok  
Tel: +662 717 8140

**TR – Turkey,** Merter/Istanbul  
Tel: +90 212 482 91 06 or 07

**TW – Taiwan,** Taipei  
Tel: +886 2 2298 8987

**UA – Ukraine,** Kyiv  
Tel: +380 44 494 2731

**UK – United Kingdom,**  
Warwick  
Tel: +44 (0)1926 317 878

**US – USA,** Cleveland  
(Industrial)  
Tel: +1 216 896 3000

**US – USA,** Lincolnshire  
(Mobile)  
Tel: +1 847 821 1500

**US – USA,** Miami  
(Pan American Division)  
Tel: +1 305 470 8800

**VE – Venezuela,** Caracas  
Tel: +58 212 238 5422

**ZA – South Africa,**  
Kempton Park  
Tel: +27 (0)11 961 0700

