



aerospace  
climate control  
electromechanical  
filtration  
fluid & gas handling  
hydraulics  
**pneumatics**  
process control  
sealing & shielding



# Pneumatic cylinders

Series P1J  
Compact cylinders

Catalogue PDE2561TCUK June 2011



ENGINEERING YOUR SUCCESS.

Features	Air cylinder	Hydraulic cylinder	Electro mechanical actuators
Overload safe	***	***	*
Easy to limit force	***	***	*
Easy to vary speed	***	***	*
Speed	***	**	**
Reliability	***	***	***
Robustness	***	***	*
Installation cost	***	*	**
Ease of service	***	**	*
Safety in damp environments	***	***	*
Safety in explosive atmospheres	***	***	*
Safety risk with electrical installations	***	***	*
Risk of oil leak	***	*	***
Clean, hygienic	***	**	*
Standardised measurements	***	***	*
Service life	***	***	*
Hydraulic system required	***	*	***
Weight	***	**	**
Purchase price	***	**	*
Power density	**	***	*
Noise level during operation	**	***	**
High force for size	**	***	*
Positioning possibilities	*	***	***
Total energy consumption	*	**	***
Service interval	*	**	***
Compressor capacity required	*	***	***

\* = good, \*\*=average, \*\*\*=excellent



**Important**  
 Before attempting any external or internal work on the cylinder or any connected components, make sure the cylinder is vented and disconnect the air supply in order to ensure isolation of the air supply.



**Note**  
 All technical data in this catalogue are typical data only.  
 Air quality is essential for maximum cylinder service life (see ISO 8573).



**WARNING**

**FAILURE OR IMPROPER SELECTION OR IMPROPER USE OF THE PRODUCTS AND/OR SYSTEMS DESCRIBED HEREIN OR RELATED ITEMS CAN CAUSE DEATH, PERSONAL INJURY AND PROPERTY DAMAGE.**

This document and other information from Parker Hannifin Corporation, its subsidiaries and authorized distributors provide product and/or system options for further investigation by users having technical expertise. It is important that you analyze all aspects of your application and review the information concerning the product or system in the current product catalog. Due to the variety of operating conditions and applications for these products or systems, the user, through its own analysis and testing, is solely responsible for making the final selection of the products and systems and assuring that all performance, safety and warning requirements of the application are met. The products described herein, including without limitation, product features, specifications, designs, availability and pricing, are subject to change by Parker Hannifin Corporation and its subsidiaries at any time without notice.

**SALE CONDITIONS**

The items described in this document are available for sale by Parker Hannifin Corporation, its subsidiaries or its authorized distributors. Any sale contract entered into by Parker will be governed by the provisions stated in Parker's standard terms and conditions of sale (copy available upon request).

<b>Contents</b>	<b>Page</b>
Cylinder series P1J, general.....	4-5
Cylinder forces .....	6
Main data.....	7
Working medium, air quality .....	7
Material specification .....	7
Side load force diagram.....	7
Guide for selecting suitable tubing .....	8
Dimensions (mm) .....	10
Order key.....	11
Standard stroke length .....	11
Order codes double acting .....	12
Order codes single acting.....	13
Guide unit.....	14
Order codes double acting, guided.....	15
Combinations .....	16
Mountings.....	17-18
Sensors.....	19
Connecting cables with one connector.....	20
Male connectors for connecting cables.....	20
Ready to use connecting cables with connectors at each end .....	20
Connection block Valvetronic 110.....	21

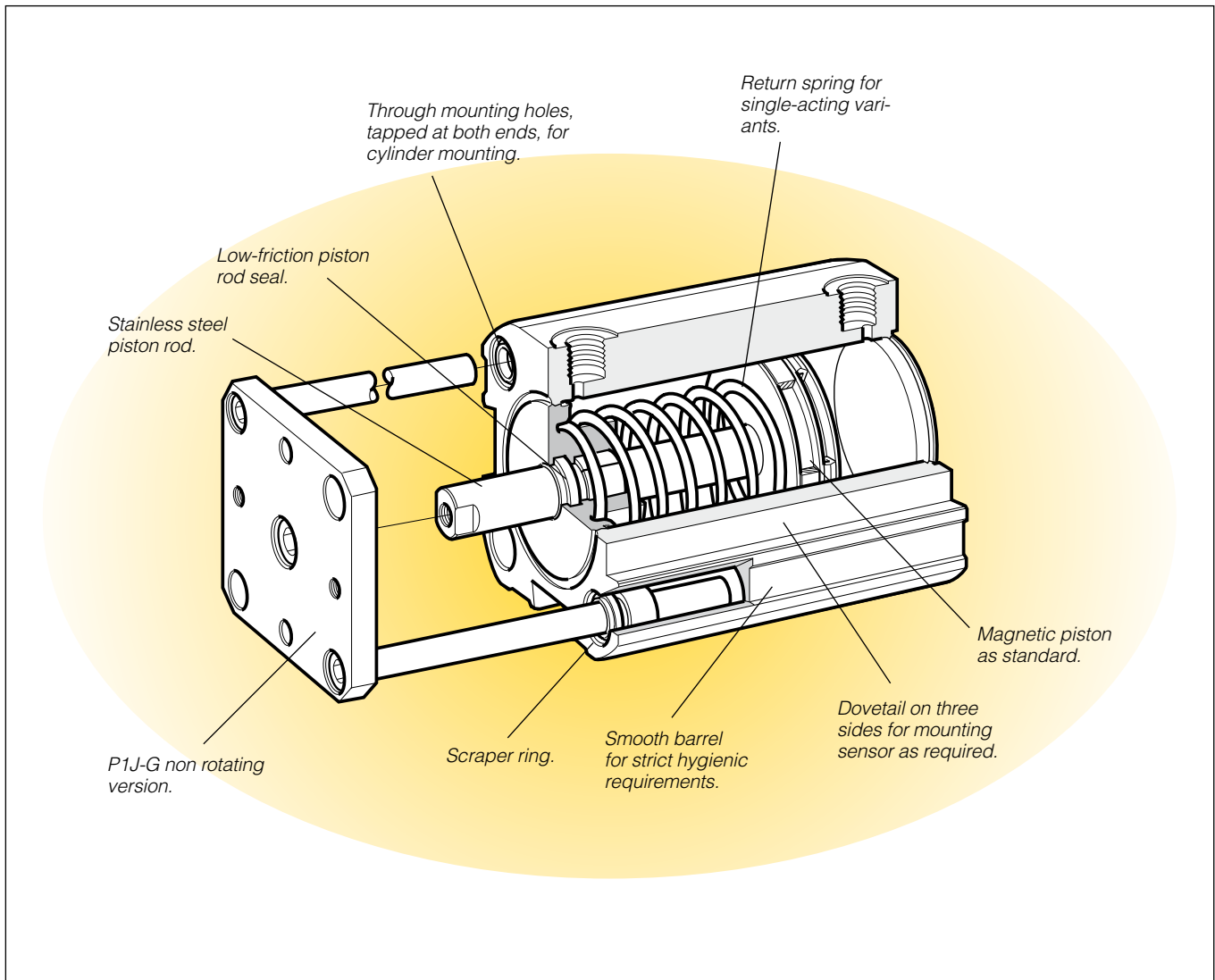

### Single acting and double acting versions

The P1J range of cylinders is intended for use in a wide range of applications. These cylinders are particularly suitable in applications such as packaging, the food industry and the textile industry.

Careful design and high quality throughout ensure long, trouble free service life.

The compact design, with through mounting holes that are countersunk and tapped at both ends, make the cylinders easy to mount, with or without mountings.

They are available in diameters of 12, 20, 25, 32, 40, 50 and 63 mm, with stroke lengths up to 100 mm.

The single acting version is available in the same bore size as the double acting version and with stroke lengths up to 50 mm. All cylinder types have magnetic pistons as standard, and are initially lubricated with our food-grade grease. Reed switch and solid state sensors are available as accessories, and can be fitted in the dovetail slots on three of the sides of the cylinder body.

### External guide device

The cylinder can be supplied with an external guide unit to prevent the piston from turning. It guides the piston rod and enables the cylinder to resist turning moments on the piston rod and/or transverse forces. The device consists of a substantial mounting plate and two guides that run along the sides of the cylinder in two bearing-support guide sleeves. The plate has pre-drilled mounting holes to aid assembly.

### Options

In addition to a large selection of standard cylinders, the P1J is available in several standard variants, such as custom stroke length, extended piston rods, double piston rods etc.

Additionally, a complete range of sensor and mounting devices is available.

## Smooth external design

There are no recesses or pockets in the end covers that could trap dirt or liquid, making cleaning simple and effective.

## Corrosion resistant

Even the basic versions of the cylinders have good corrosion resistance through appropriate choice of materials and surface treatment, allowing them to be used in demanding environments.

As the end face of the cylinders is not fully anodised in the standard version, extra anodising can be specified when ordering to provide extra corrosion protection.

## Piston sensing

A complete range of sensors for piston sensing is available as accessories: both reed switch and solid state sensors are available. They are supplied with either a flying lead or with a cable plug connector, with a moulded cable.

## Mounting

A range of mountings with appropriate surface finish is available as accessories.

## Variants

In addition to the basic versions, P1J cylinders are available in several standard variants:

- Cylinders with non-standard stroke lengths
- Cylinders with extended piston rods
- Cylinders with through piston rod
- Cylinders with through, hollow piston rod
- Single-acting cylinders
- Cylinders with anodised end faces
- Cylinders with piston rod guides

Double acting

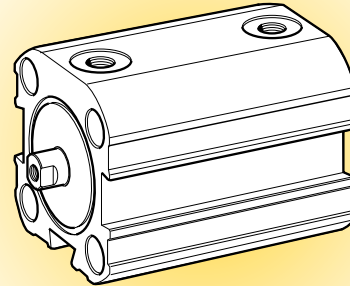

Double acting, through piston rod

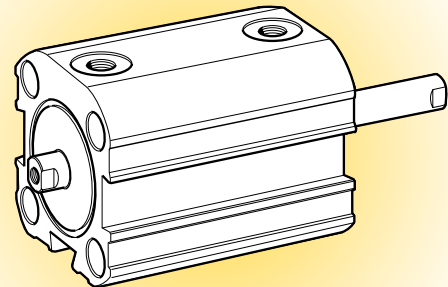

Single acting, spring return

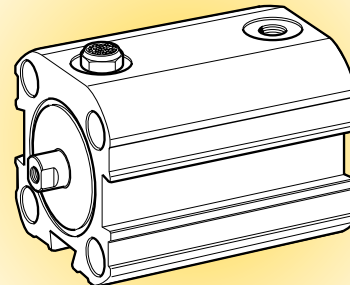

Double acting, guided piston rod

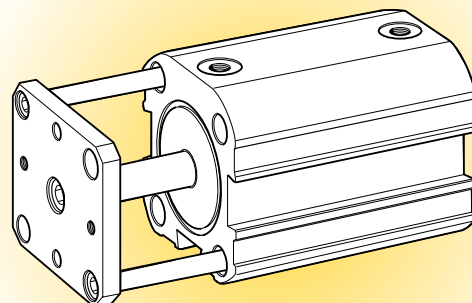

## Cylinder forces, double acting variants

Cyl. bore/ pist. rod mm	Stroke	Piston area cm <sup>2</sup>	Max theoretical force in N (bar)									
			1,0	2,0	3,0	4,0	5,0	6,0	7,0	8,0	9,0	10,0
12/6	+	1,1	11	23	34	45	57	68	79	90	102	113
	-	0,8	8	17	25	34	42	51	59	68	76	85
20/10	+	3,1	31	63	94	126	157	188	220	251	283	314
	-	2,3	23	46	69	92	115	138	161	184	207	231
25/10	+	4,9	49	98	147	196	245	295	344	393	442	491
	-	4,1	41	82	124	165	206	247	289	330	371	412
32/12	+	8,0	80	161	241	322	402	483	563	643	724	804
	-	6,9	69	138	207	276	346	415	484	553	622	691
40/12	+	12,6	126	251	377	503	628	754	880	1005	1131	1257
	-	11,4	114	229	343	457	572	686	800	915	1029	1144
50/16	+	19,6	196	393	589	785	982	1178	1374	1571	1767	1963
	-	17,6	176	352	529	705	881	1057	1234	1410	1586	1762
63/16	+	31,2	312	623	935	1247	1559	1870	2182	2494	2806	3117
	-	29,2	292	583	875	1166	1548	1750	2041	2333	2625	2916

+ = Outward stroke  
- = Return stroke

**Note!**

Select a theoretical force 50-100%  
larger than the force required

## Cylinder forces single acting variants

Indicated cylinder forces are theoretical and should be reduced  
according to the working conditions.

Order code	Theoretical piston force at 6 bar				Order code	Theoretical piston force at 6 bar			
	+ stroke		Spring retraction			+ stroke		Spring retraction	
	Nmax	Nmin	Nmax	Nmin		Nmax	Nmin	Nmax	Nmin
<b>Single acting,</b>					<b>Single acting,</b>				
P1J-S012SS-0005	59	58	9	8	P1J-S040SS-0005	704	701	53	50
P1J-S012SS-0010	60	58	9	7	P1J-S040SS-0010	706	701	53	48
P1J-S012SS-0015	61	58	9	6	P1J-S040SS-0015	709	701	53	45
					P1J-S040SS-0020	712	701	53	42
P1J-S020SS-0005	159	156	32	29	P1J-S040SS-0025	715	701	53	39
P1J-S020SS-0010	161	156	32	27	P1J-S040SS-0030	718	701	53	36
P1J-S020SS-0015	164	156	32	24	P1J-S040SS-0040	712	701	53	42
P1J-S020SS-0020	166	156	32	22	P1J-S040SS-0050	715	701	53	39
P1J-S020SS-0025	169	156	32	19					
P1J-S020SS-0030	172	156	32	16	P1J-S050SS-0005	1088	1079	99	90
					P1J-S050SS-0010	1096	1079	99	82
P1J-S025SS-0005	265	262	32	29	P1J-S050SS-0015	1105	1079	99	73
P1J-S025SS-0010	267	262	32	27	P1J-S050SS-0020	1114	1079	99	64
P1J-S025SS-0015	270	262	32	24	P1J-S050SS-0025	1123	1079	99	55
P1J-S025SS-0020	272	262	32	22	P1J-S050SS-0030	1131	1079	99	47
P1J-S025SS-0025	275	262	32	19	P1J-S050SS-0040	1114	1079	99	64
P1J-S025SS-0030	278	262	32	16	P1J-S050SS-0050	1123	1079	99	55
P1J-S025SS-0040	272	262	32	22					
P1J-S025SS-0050	275	262	32	19	P1J-S063SS-0005	1774	1767	103	96
					P1J-S063SS-0010	1780	1767	103	90
P1J-S032SS-0005	439	436	46	43	P1J-S063SS-0015	1786	1767	103	84
P1J-S032SS-0010	442	436	46	40	P1J-S063SS-0020	1793	1767	103	77
P1J-S032SS-0015	445	436	46	37	P1J-S063SS-0025	1799	1767	103	71
P1J-S032SS-0020	447	436	46	35	P1J-S063SS-0030	1806	1767	103	64
P1J-S032SS-0025	450	436	46	32	P1J-S063SS-0040	1793	1767	103	77
P1J-S032SS-0030	453	436	46	29	P1J-S063SS-0050	1799	1767	103	71
P1J-S032SS-0040	447	436	46	35					
P1J-S032SS-0050	450	436	46	32					



## Main data

Cylinder designation	Cylinder		Piston rod			Basic weight		Guided weight		Air consumption Litres	Port thread
	Bore	Area	Diam.	Area	Thread (female)	at 0 mm stroke	addition per 10 mm stroke	at 0 mm stroke	addition per 10 mm stroke		
	mm	cm <sup>2</sup>	mm	cm <sup>2</sup>		kg	kg	kg	kg		
<b>Double acting</b>											
P1J-S 012 DS	12	1,13	6	0,28	M3	0,06	0,016	-	-	0,0139 <sup>1)</sup>	M5
P1J-S 020 DS	20	3,14	10	0,78	M5	0,13	0,030	0,17	0,033	0,0385 <sup>1)</sup>	M5
P1J-S 025 DS	25	4,91	10	0,78	M5	0,15	0,035	0,21	0,038	0,0633 <sup>1)</sup>	M5
P1J-S 032 DS	32	8,04	12	1,13	M6	0,20	0,044	0,27	0,050	0,1050 <sup>1)</sup>	G1/8
P1J-S 040 DS	40	12,6	12	1,13	M6	0,29	0,054	0,40	0,058	0,1680 <sup>1)</sup>	G1/8
P1J-S 050 DS	50	19,6	16	2,01	M8	0,50	0,070	0,65	0,080	0,2610 <sup>1)</sup>	G1/8
P1J-S 063 DS	63	31,2	16	2,01	M8	0,77	0,100	1,08	0,110	0,4220 <sup>1)</sup>	G1/8
<b>Single acting</b>											
P1J-S 012 SS	12	1,13	6	0,28	M3	0,06	0,016	-	-	0,0079 <sup>1)</sup>	M5
P1J-S 020 SS	20	3,14	10	0,78	M5	0,13	0,030	0,17	0,033	0,0220 <sup>1)</sup>	M5
P1J-S 025 SS	25	4,91	10	0,78	M5	0,16	0,035	0,22	0,038	0,0344 <sup>1)</sup>	M5
P1J-S 032 SS	32	8,04	12	1,13	M6	0,21	0,044	0,28	0,050	0,0563 <sup>1)</sup>	G1/8
P1J-S 040 SS	40	12,6	12	1,13	M6	0,30	0,054	0,41	0,058	0,0882 <sup>1)</sup>	G1/8
P1J-S 050 SS	50	19,6	16	2,01	M8	0,52	0,070	0,67	0,080	0,1372 <sup>1)</sup>	G1/8
P1J-S 063 SS	63	31,2	16	2,01	M8	0,80	0,100	1,11	0,110	0,2184 <sup>1)</sup>	G1/8

1) Free air consumption per 10 mm stroke length for a double stroke at a pressure of 600 kPa (6 bar)

## Working medium, air quality

Working medium Dry, filtered compressed air to ISO 8573-1 class 3.4.3.

### Recommended air quality for cylinders

For best possible service life and trouble-free operation, ISO 8573-1 quality class 3.4.3 should be used. This means 5 µm filter (standard filter) dew point +3 °C for indoor operation (a lower dew point should be selected for outdoor operation) and oil concentration 1.0 mg oil/m<sup>3</sup>, which is what a standard compressor with a standard filter gives.

### ISO 8573-1 quality classes

Quality class	Pollution particle size (µm)	max concentration (mg/m <sup>3</sup> )	Water max. press. dew point (°C)	Oil max concentration (mg/m <sup>3</sup> )
1	0,1	0,1	-70	0,01
2	1	1	-40	0,1
3	5	5	-20	1,0
4	15	8	+3	5,0
5	40	10	+7	25
6	-	-	+10	-

## Material specification

### Double and single-acting

Piston rod	Stainless steel, DIN X10 CrNiS 18 9
Piston rod seal	Nitrile rubber, NBR
Piston rod bearing, Ø20-Ø63 mm	Multi-layer PTFE/bronze/steel
Piston bearing, Ø20-Ø63 mm	UHMWPE plastic
A-cover, Ø12 mm	Brass
End cover	Aluminium
Locking ring, Ø12 mm	Surface-finished steel
O-ring, cover, Ø12 mm	Nitrile rubber, NBR
Barrel	Anodised aluminium
Piston, Ø12 mm	Brass
Piston, Ø20-Ø63 mm	Aluminium
Piston seal	Nitrile rubber, NBR
Return spring, Ø12 mm	Stainless steel
Return spring, Ø20-Ø63 mm	Surface-treated steel

## Other data

Working pressure	Max. 10 bar
Working temperature	Max +80 °C
	Min -20 °C

Prelubricated, further lubrication is not normally necessary. If additional lubrication is introduced it must be continued.

## Side load force diagram

Permissible side loading as a function of piston rod extension. Side load [N]

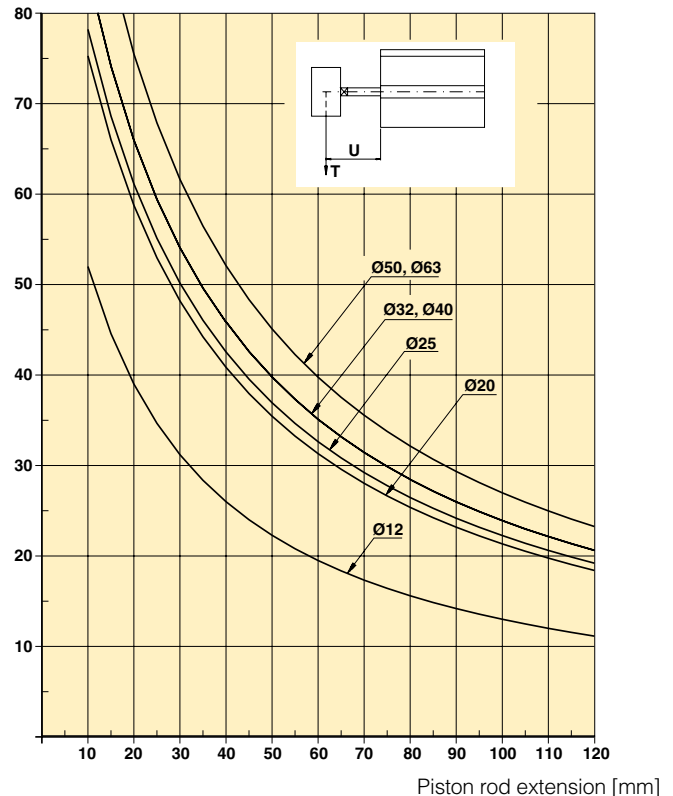

**Guide for selecting suitable tubing**

The selection of the correct size of tubing is often based on experience, with no great thought to optimizing energy efficiency and cylinder velocity. This is usually acceptable, but making a rough calculation can result in worthwhile economic gains.

**The following is the basic principle:**

1. The primary line to the working valve could be over sized (this does not cause any extra air consumption and consequently does not create any extra costs in operation).
2. The tubes between the valve and the cylinder should, however, be optimized according to the principle that an insufficient bore throttles the flow and thus limits the cylinder speed, while an oversized pipe creates a dead volume which increases the air consumption and filling time.

The chart below is intended to help when selecting the correct size of tube to use between the valve and the cylinder.

**The following prerequisites apply:**

The cylinder load should be about 50% of the theoretical force (= normal load). A lower load gives a higher velocity and vice versa. The tube size is selected as a function of the cylinder bore, the desired cylinder velocity and the tube length between the valve and the cylinder.

If you want to use the capacity of the valve to its maximum, and obtain maximum speed, the tubing should be chosen so that they at least correspond with the equivalent restriction diameter (see description below), so that the tubing does not restrict the total flow. This means that a short tubing must have at least the equivalent restriction diameter. If the tubing is longer, choose it from the table below. Straight fittings should be chosen for highest flow rates. (Elbow and banjo fittings cause restriction.)

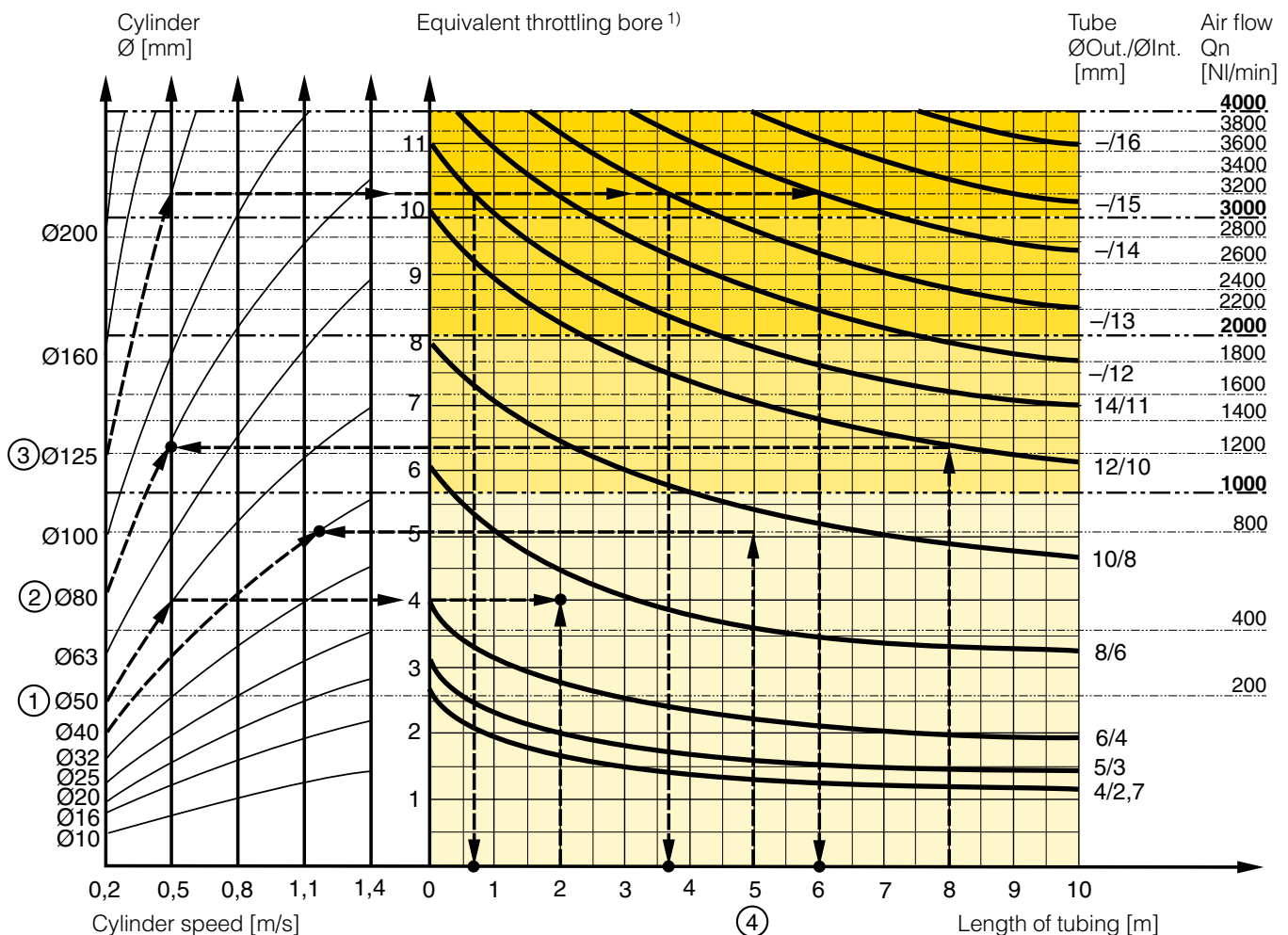

- 1) The "equivalent throttling bore" is a long throttle (for example a tube) or a series of throttles (for example, through a valve) converted to a short throttle which gives a corresponding flow rate. This should not be confused with the "orifice" which is sometimes specified for valves. The value for the orifice does not normally take account of the fact that the valve contains a number of throttles.
- 2) Qn is a measure of the valve flow capacity, with flow measured in litre per minute (l/min) at 6 bar(e) supply pressure and 1 bar pressure drop across the valve.



**Example ①: Which tube diameter should be used?**

A 50 mm bore cylinder is to be operated at 0.5 m/s. The tube length between the valve and cylinder is 2 m. In the diagram we follow the line from 50 mm bore to 0.5 m/s and get an "equivalent throttling bore" of approximately 4 mm. We continue out to the right in the chart and intersect the line for a 2 m tube between the curves for 4 mm (6/4 tube) and 6 mm (8/6 tube). This means that a 6/4 tube throttles the velocity somewhat, while an 8/6 tube is a little too large. We select the 8/6 tube to obtain full cylinder velocity.

**Example ②: What cylinder velocity will be obtained?**

A 80 mm bore cylinder will be used, connected by 8 m 12/10 tube to a P2L-B valve. What cylinder velocity will we get? We refer to the diagram and follow the line from 8 mm tube length up to the curve for 12/10 tube. From there, we go horizontally to the curve for the Ø80 cylinder. We find that the velocity will be about 0.5 m/s.

**Example ③: What is the minimum inner diameter and maximum length of tube?**

For an application a 125 mm bore cylinder will be used. Maximum velocity of piston rod is 0.5 m/s. The cylinder will be controlled by a P2L-D valve. What diameter of tube can be used and what is maximum length of tube. We refer to the diagram. We start at the left side of the diagram cylinder Ø125. We follow the line until the intersection with the velocity line of 0.5 m/s. From here we draw a horizontal line in the diagram. This line shows us we need an equivalent throttling bore of approximately 10 mm. Following this line horizontally we cross a few intersections. These intersections shows us the minimum inner diameter (rightside diagram) in combination with the maximum length of tube (bottomside diagram).

For example:

Intersection one: When a tube (14/11) will be used, the maximum length of tube is 0.7 meter.

Intersection two: When a tube (—/13) will be used, the maximum length of tube is 3.7 meter.

Intersection three: When a tube (—/14) will be used, the maximum length of tube is 6 meter.

**Example ④: Determining tube size and cylinder velocity with a particular cylinder and valve?**

For an application using a 40 mm bore cylinder with a valve with Qn=800 NI/min. The distance between the cylinder and valve has been set to 5 m.

**Tube dimension:** What tube bore should be selected to obtain the maximum cylinder velocity? Start at pipe length 5 m, follow the line up to the intersection with 800 NI/min. Select the next largest tube diameter, in this case Ø10/8 mm.

**Cylinder velocity:** What maximum cylinder velocity will be obtained? Follow the line for 800 NI/min to the left until it intersects with the line for the Ø40 mm cylinder. In this example, the speed is just above 1.1 m/s.

**Valve series with respective flows in NI/minute**

Valve series	Qn in NI/Min
Valvetronic Solstar	33
Interface PS1	100
Adex A05	173
Moduflex size 1, (2 x 3/2)	220
Valvetronic PVL-B 5/3 closed centre, 6 mm push in	290
Moduflex size 1, (4/2)	320
B43 Manual and mechanical	340
Valvetronic PVL-B 2 x 2/3, 6 mm push in	350
Valvetronic PVL-B 5/3 closed centre, G1/8	370
Compact Isomax DX02	385
Valvetronic PVL-B 2 x 3/2 G1/8	440
Valvetronic PVL-B 5/2, 6 mm push in	450
Valvetronic PVL-B 5/3 vented centre, 6 mm push in	450
Moduflex size 2, (2 x 3/2)	450
Flowstar P2V-A	520
Valvetronic PVL-B 5/3 vented centre, G1/8	540
Valvetronic PVL-B 5/2, G1/8	540
Valvetronic PVL-C 2 x 3/2, 8 mm push in	540
Adex A12	560
Valvetronic PVL-C 2 x 3/2 G1/8	570
Compact Isomax DX01	585
VIKING Xtreme P2LAX	660
Valvetronic PVL-C 5/3 closed centre, 8 mm push in	700
Valvetronic PVL-C 5/3 vented centre, G1/4	700
B3-Series	780
Valvetronic PVL-C 5/3 closed centre, G1/4	780
Moduflex size 2, (4/2)	800
Valvetronic PVL-C 5/2, 8 mm push in	840
Valvetronic PVL-C 5/3 vented centre, 8 mm push in	840
Valvetronic PVL-C 5/2, G1/4	840
Flowstar P2V-B	1090
ISOMAX DX1	1150
B53 Manual and mechanical	1160
B4-Series	1170
VIKING Xtreme P2LBX	1290
B5-Series, G1/4	1440
Airline Isolator Valve VE22/23	1470
ISOMAX DX2	2330
VIKING Xtreme P2LCX, G3/8	2460
VIKING Xtreme P2LDX, G1/2	2660
ISOMAX DX3	4050
Airline Isolator Valve VE42/43	5520
Airline Isolator Valve VE82/83	13680

## Double and single acting cylinders



CAD drawings on the Internet

Our home page [www.parker.com/euro\\_pneumatic](http://www.parker.com/euro_pneumatic) includes the AirCad Drawing Library with 2D and 3D drawings for the main versions.

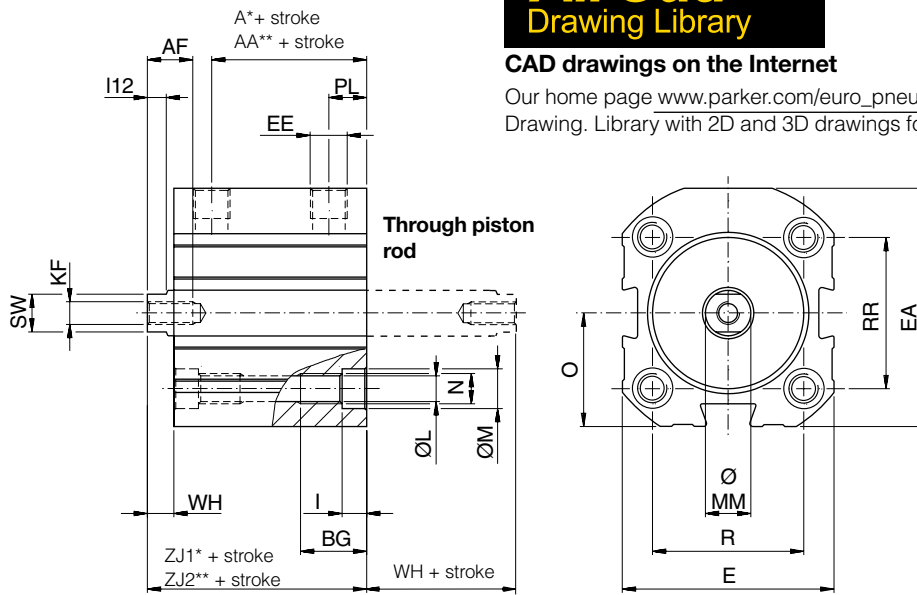

## Guided cylinder

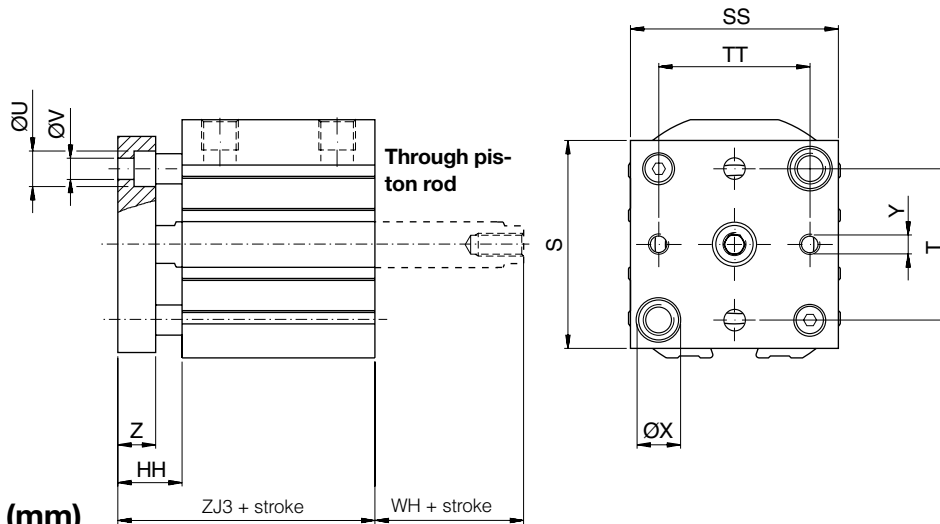

## Dimensions (mm)

Cylinder bore	A*	AA**	AF	BG	E	EA	EE	HH	I	KF	L	I12	M	MM	N	O	PL
12	25,0	-	5	9	26	30,0	M5	-	3,5	M3	3,4	3,0	6,1	6	M4	15,0	6,5
20	31,5	-	10	15	33	43,0	M5	14,8	5,5	M5	5,3	4,5	9,2	10	M6	21,5	6,5
25	32,5	47,5	10	15	40	44,5	M5	16,0	5,5	M5	5,3	4,5	9,2	10	M6	22,5	6,5
32	32,6	50,6	12	15	46	54,0	G1/8	15,7	5,5	M6	5,3	5,0	9,2	12	M6	25,5	10,0
40	34,0	52,0	12	18	56	63,0	G1/8	17,0	6,5	M6	6,9	5,0	10,5	12	M8	30,0	10,0
50	38,5	56,5	12	18	66	73,0	G1/8	19,0	6,5	M8	6,9	5,5	10,5	16	M8	35,0	10,0
63	40,0	60,0	12	25	83	87,5	G1/8	20,0	9,0	M8	9,3	5,5	15,0	16	M10	41,5	10,0

Cylinder bore	R	RR	S	SS	SW	T	TT	U	V	WH	X	Y	Z	ZJ1*	ZJ2**	ZJ3
12	13	18	-	-	5	-	-	-	-	4,0	-	-	-	38,0	-	-
20	20	30	42	32	8	22	22	8,0	4,5	4,8	9,4	M4	10	42,8	-	52,8
25	27	27	40	39	8	28	26	8,0	4,5	6,0	9,4	M4	10	45,0	60,0	45,5
32	32	36	48	45	10	36	32	9,4	5,5	5,7	9,4	M4	10	45,5	63,5	55,5
40	40	40	55	55	10	40	40	9,4	5,5	7,0	11,5	M5	10	47,0	65,0	57,0
50	50	50	65	65	13	50	50	11,5	6,5	7,0	11,5	M6	12	53,0	71,0	65,0
63	62	62	80	80	13	62	62	14,5	9,0	8,0	14,5	M6	12	57,0	77,0	69,0

\* A and ZJ1 = Double acting cylinders and single acting cylinders up to stroke length 30 mm

\*\* AA and ZJ2 = Single acting cylinders, stroke length 31 to 50 mm

Length tolerances ±1 mm

Stroke length tolerances +1.5/0 mm

## Order key

P
1
J
-
S
0
3
2
D
S
-
0
0
2
5

Cylinder bore mm	
012	
020	
025	
032	
040	
050	
063	

Cylindertype/Function	
D	Double-acting, Ø12 - Ø63
K	Double-acting, through piston rod, Ø20 - Ø63
P	Double-acting, through piston rod hollow, Ø20 - Ø63, Not cylinder version G
S	Single-acting, spring return for retract stroke, Ø12 - Ø63

Stroke length mm	
E.g. 0025	= 25 mm
For standard stroke length and max length see tabel below.	

Cylinder version	
S	Standard cylinder
K	Cylinder with end cover in anodised aluminium.
G	Cylinder with mounted guide unit, Ø20 - Ø63.

Sealing material	
S	Standard seals, -20 °C to +80 °C Stainless steel piston rod Magnetic piston

## Standard stroke length

Cylinder designation	Cylinder bore	● Standard stroke length in mm									
		5	10	15	20	25*	30	40	50*	80*	100*
<b>Double acting:</b>											
P1J-S012D	12	●	●	●	●	●					
P1J-S020D	20	●	●	●	●	●	●	●	●		
P1J-S025D	25	●	●	●	●	●	●	●	●	●	
P1J-S032D	32	●	●	●	●	●	●	●	●	●	●
P1J-S040D	40	●	●	●	●	●	●	●	●	●	●
P1J-S050D	50	●	●	●	●	●	●	●	●	●	●
P1J-S063D	63	●	●	●	●	●	●	●	●	●	●
<b>Double acting with guide unit:</b>											
P1J-G020D	20	●	●	●	●	●	●	●	●		
P1J-G025D	25	●	●	●	●	●	●	●	●	●	
P1J-G032D	32	●	●	●	●	●	●	●	●	●	●
P1J-G040D	40	●	●	●	●	●	●	●	●	●	●
P1J-G050D	50	●	●	●	●	●	●	●	●	●	●
P1J-G063D	63	●	●	●	●	●	●	●	●	●	●
<b>Single acting:</b>											
P1J-S012S	12	●	●	●							
P1J-S020S	20	●	●	●	●	●					
P1J-S025S	25	●	●	●	●	●	●	●			
P1J-S032S	32	●	●	●	●	●	●	●	●		
P1J-S040S	40	●	●	●	●	●	●	●	●	●	
P1J-S050S	50	●	●	●	●	●	●	●	●	●	●
P1J-S063S	63	●	●	●	●	●	●	●	●	●	●

\* Standard stroke length in mm according to ISO 4393

## Data

Working pressure	Max. 10 bar
Working temperature	Max. +80 °C
	Min. -20 °C

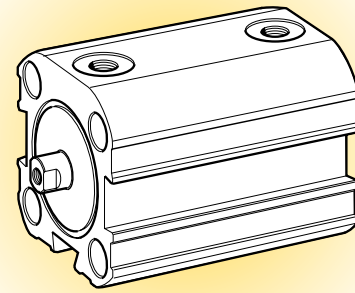

## Double acting

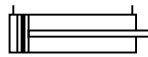

Cyl. bore mm	Stroke mm	Order code
<b>12</b> M5 thread	05	P1J-S012DS-0005
	10	P1J-S012DS-0010
	15	P1J-S012DS-0015
	20	P1J-S012DS-0020
	25	P1J-S012DS-0025
<b>20</b> M5 thread	05	P1J-S020DS-0005
	10	P1J-S020DS-0010
	15	P1J-S020DS-0015
	20	P1J-S020DS-0020
	25	P1J-S020DS-0025
	30	P1J-S020DS-0030
	40	P1J-S020DS-0040
<b>25</b> M5 thread	05	P1J-S025DS-0005
	10	P1J-S025DS-0010
	15	P1J-S025DS-0015
	20	P1J-S025DS-0020
	25	P1J-S025DS-0025
	30	P1J-S025DS-0030
	40	P1J-S025DS-0040
<b>32</b> G1/8 thread	05	P1J-S032DS-0005
	10	P1J-S032DS-0010
	15	P1J-S032DS-0015
	20	P1J-S032DS-0020
	25	P1J-S032DS-0025
	30	P1J-S032DS-0030
	40	P1J-S032DS-0040
	50	P1J-S032DS-0050
	80	P1J-S032DS-0080

## Double acting

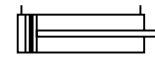

Cyl. bore mm	Stroke mm	Order code
<b>40</b> G1/8 thread	05	P1J-S040DS-0005
	10	P1J-S040DS-0010
	15	P1J-S040DS-0015
	20	P1J-S040DS-0020
	25	P1J-S040DS-0025
	30	P1J-S040DS-0030
	40	P1J-S040DS-0040
	50	P1J-S040DS-0050
<b>50</b> G1/8 thread	05	P1J-S050DS-0005
	10	P1J-S050DS-0010
	15	P1J-S050DS-0015
	20	P1J-S050DS-0020
	25	P1J-S050DS-0025
	30	P1J-S050DS-0030
	40	P1J-S050DS-0040
	50	P1J-S050DS-0050
<b>63</b> G1/8 thread	05	P1J-S063DS-0005
	10	P1J-S063DS-0010
	15	P1J-S063DS-0015
	20	P1J-S063DS-0020
	25	P1J-S063DS-0025
	30	P1J-S063DS-0030
	40	P1J-S063DS-0040
	50	P1J-S063DS-0050
	80	P1J-S063DS-0080
	100	P1J-S063DS-0100

## Data

Working pressure	Max. 10 bar
Working temperature	Max. +80 °C Min. -20 °C

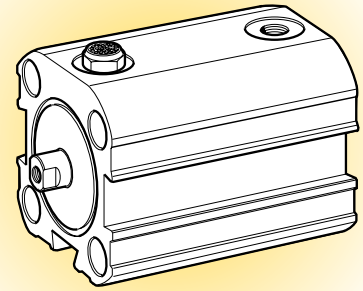

## Single acting

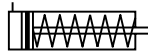

Cyl. bore mm	Stroke mm	Order code
<b>12</b> M5 thread	05	P1J-S012SS-0005
	10	P1J-S012SS-0010
	15	P1J-S012SS-0015
<b>20</b> M5 thread	05	P1J-S020SS-0005
	10	P1J-S020SS-0010
	15	P1J-S020SS-0015
	20	P1J-S020SS-0020
	25	P1J-S020SS-0025
	30	P1J-S020SS-0030
<b>25</b> M5 thread	05	P1J-S025SS-0005
	10	P1J-S025SS-0010
	15	P1J-S025SS-0015
	20	P1J-S025SS-0020
	25	P1J-S025SS-0025
	30	P1J-S025SS-0030
	40	P1J-S025SS-0040
	50	P1J-S025SS-0050
<b>32</b> G1/8 thread	05	P1J-S032SS-0005
	10	P1J-S032SS-0010
	15	P1J-S032SS-0015
	20	P1J-S032SS-0020
	25	P1J-S032SS-0025
	30	P1J-S032SS-0030
	40	P1J-S032SS-0040
	50	P1J-S032SS-0050

## Single acting

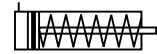

Cyl. bore mm	Stroke mm	Order code
<b>40</b> G1/8 thread	05	P1J-S040SS-0005
	10	P1J-S040SS-0010
	15	P1J-S040SS-0015
	20	P1J-S040SS-0020
	25	P1J-S040SS-0025
	30	P1J-S040SS-0030
<b>50</b> G1/8 thread	40	P1J-S040SS-0040
	50	P1J-S040SS-0050
	05	P1J-S050SS-0005
	10	P1J-S050SS-0010
	15	P1J-S050SS-0015
	20	P1J-S050SS-0020
	25	P1J-S050SS-0025
	30	P1J-S050SS-0030
<b>63</b> G1/8 thread	40	P1J-S050SS-0040
	50	P1J-S050SS-0050
	05	P1J-S063SS-0005
	10	P1J-S063SS-0010
	15	P1J-S063SS-0015
	20	P1J-S063SS-0020
	25	P1J-S063SS-0025
	30	P1J-S063SS-0030
40	P1J-S063SS-0040	
50	P1J-S063SS-0050	

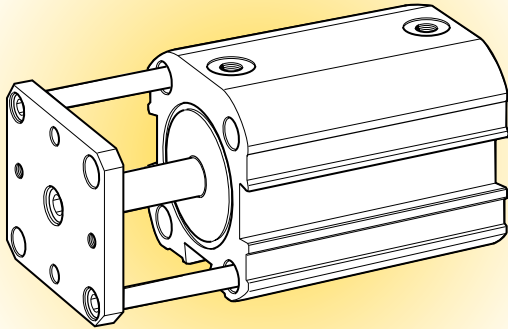

**Technical data**

Working medium	Dry, filtered compressed air
Working pressure	Max. 10 bar
Working temperature	-20 °C to +80 °C

**Materials, external guide device**

Mounting plate	Anodised aluminium
Guides	Stainless steel, DIN X 10 CrNiS 18 9
Sleeves	Multi-layer, PTFE/bronze/steel
Securing bolts	Surface-finished steel

Other data as for the basic cylinder.

**Guide unit**

The P1J cylinders can be fitted with an external guide unit to prevent the piston rod from turning. It guides the piston rod and enables the cylinder to resist turning torques on the piston rod and/or transverse forces.

The device consists of a substantial mounting plate and twin guide rods that run in two support bearings. The mounting plate, which has pre-drilled mounting holes, is connected to the piston rod.

The device is available for 20, 25, 32, 40, 50 and 63 mm diameter cylinders, with stroke lengths from 5 to 100 mm. Order codes on Pages 6 and 10.

**Permissible side loading**

Permissible side loading as a function of the load distance as shown below.

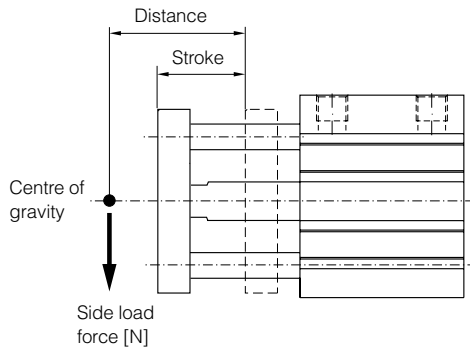

**Side load diagram**

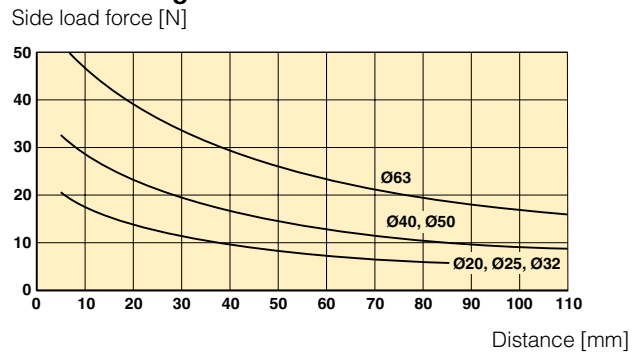

**Permissible Torque**

Permissible torque as shown below as a function of the load distance as shown in the load figure above.

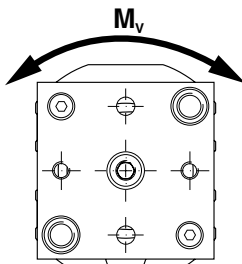

**Torque diagram**

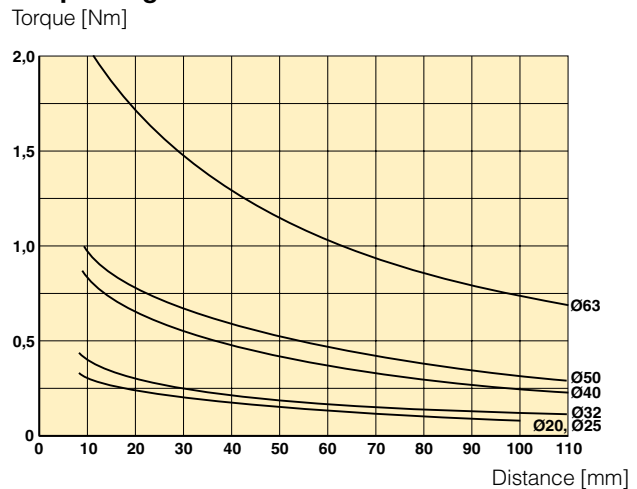



## Data

Working pressure	Max. 10 bar
Working temperature	Max. +80 °C Min. -20 °C

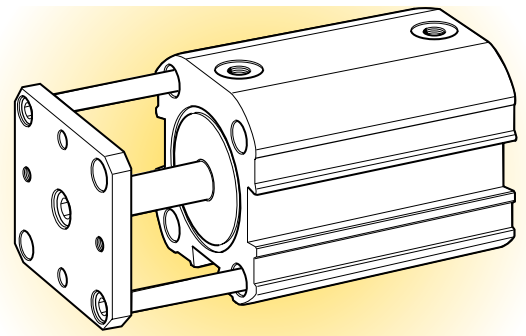

### Double acting, guided

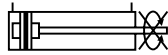

Cyl. bore mm	Stroke mm	Order code
<b>20</b> M5 thread	05	P1J-G020DS-0005
	10	P1J-G020DS-0010
	15	P1J-G020DS-0015
	20	P1J-G020DS-0020
	25	P1J-G020DS-0025
	30	P1J-G020DS-0030
	40	P1J-G020DS-0040
	50	P1J-G020DS-0050
<b>25</b> M5 thread	05	P1J-G025DS-0005
	10	P1J-G025DS-0010
	15	P1J-G025DS-0015
	20	P1J-G025DS-0020
	25	P1J-G025DS-0025
	30	P1J-G025DS-0030
	40	P1J-G025DS-0040
M5 thread	50	P1J-G025DS-0050
<b>32</b> G1/8 thread	05	P1J-G032DS-0005
	10	P1J-G032DS-0010
	15	P1J-G032DS-0015
	20	P1J-G032DS-0020
	25	P1J-G032DS-0025
	30	P1J-G032DS-0030
	40	P1J-G032DS-0040
	50	P1J-G032DS-0050
	80	P1J-G032DS-0080

### Double acting, guided

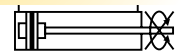

Cyl. bore mm	Stroke mm	Order code	
<b>40</b> G1/8 thread	05	P1J-G040DS-0005	
	10	P1J-G040DS-0010	
	15	P1J-G040DS-0015	
	20	P1J-G040DS-0020	
	25	P1J-G040DS-0025	
	30	P1J-G040DS-0030	
	40	P1J-G040DS-0040	
	50	P1J-G040DS-0050	
	80	P1J-G040DS-0080	
<b>50</b> G1/8 thread	05	P1J-G050DS-0005	
	10	P1J-G050DS-0010	
	15	P1J-G050DS-0015	
	20	P1J-G050DS-0020	
	25	P1J-G050DS-0025	
	30	P1J-G050DS-0030	
	40	P1J-G050DS-0040	
	50	P1J-G050DS-0050	
	80	P1J-G050DS-0080	
<b>63</b> G1/8 thread	05	P1J-G063DS-0005	
	10	P1J-G063DS-0010	
	15	P1J-G063DS-0015	
	20	P1J-G063DS-0020	
	25	P1J-G063DS-0025	
	30	P1J-G063DS-0030	
	40	P1J-G063DS-0040	
	50	P1J-G063DS-0050	
	80	P1J-G063DS-0080	
		100	P1J-G063DS-0100

Combinations

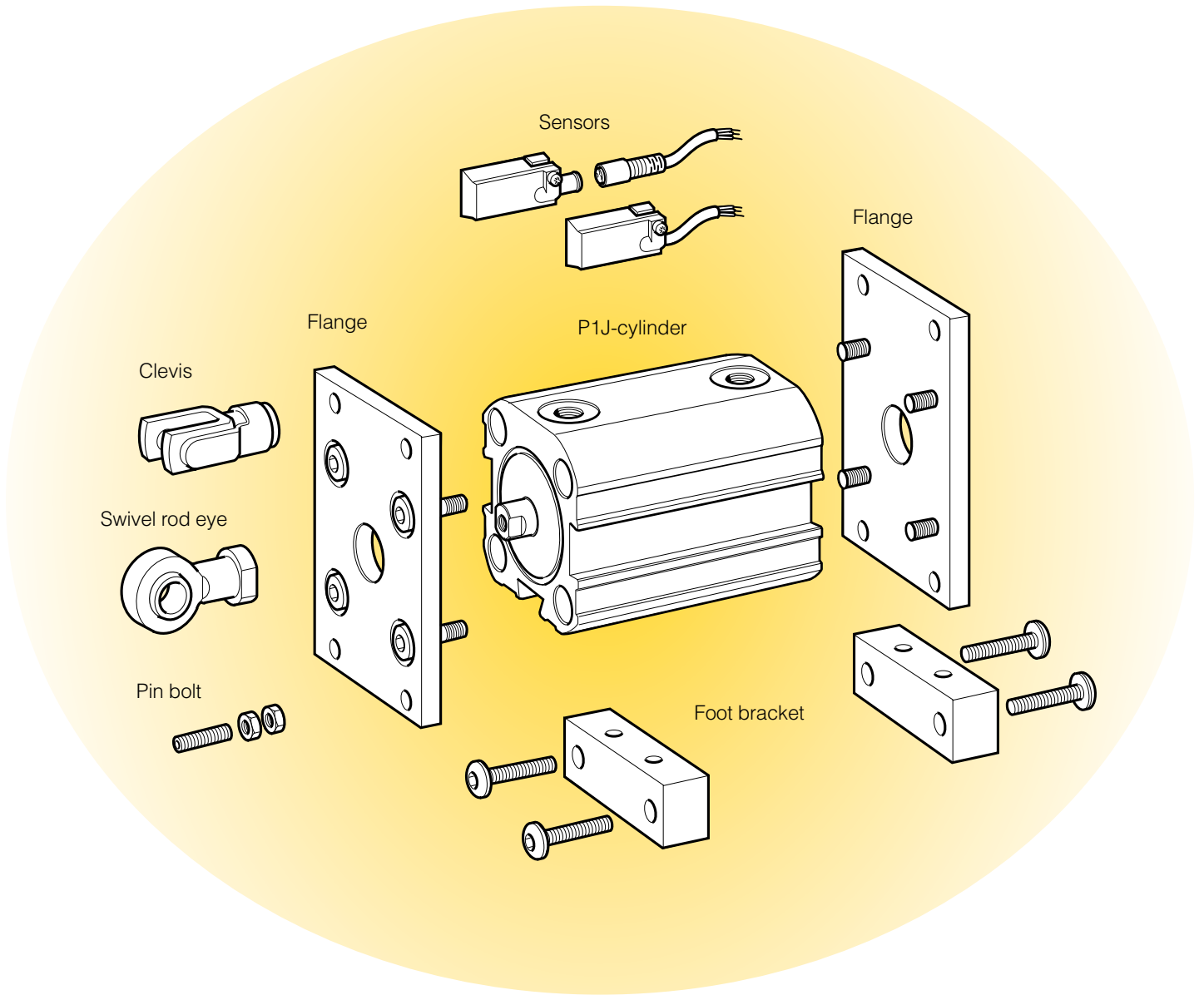

## Cylinder mountings

Type	Description	Cyl. bore Ø mm	Mass kg	Order code
<b>Flange, MF1</b>	Intended for fixed mounting of cylinder. This bracket can be fitted to front or rear end covers.  Material: Bracket: Anodised aluminium Screws: Zinc plated steel	12	0,012	<b>P1J-4DMB</b> <b>P1J-4HMB</b> <b>P1J-4JMB</b> <b>P1J-4KMB</b> <b>P1J-4LMB</b> <b>P1J-4MMB</b> <b>P1J-4NMB</b>
		20	0,031	
		25	0,036	
		32	0,052	
		40	0,124	
		50	0,151	
		63	0,306	

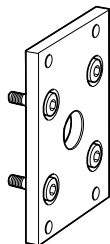

Cyl. Ø mm	A mm	B mm	C mm	D mm	E mm	F mm	G mm
12	25,4	18	38	46,0	3,6	10	4,8
20	38,0	24	50	58,0	3,6	15	6,0
25	40,0	28	54	63,5	4,6	15	6,0
32	48,0	36	66	76,0	4,6	15	6,0
40	63,5	42	78	92,0	6,6	20	9,5
50	70,0	50	90	102,0	6,6	25	9,5
63	85,0	63	110	127,0	8,6	25	12,7

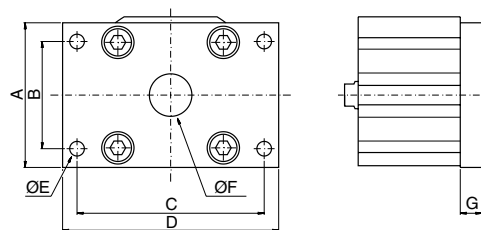

## Foot bracket

Intended for fixed mounting of cylinder. This bracket can be fitted to front or rear end covers.

Material:  
Bracket: Anodised aluminium  
Screws: Zinc plated steel

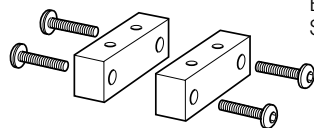

12	0,015	<b>P1J-4DMF</b> <b>P1J-4HMF</b> <b>P1J-4JMF</b> <b>P1J-4KMF</b> <b>P1J-4LMF</b> <b>P1J-4MMF</b> <b>P1J-4NMF</b>
20	0,016	
25	0,034	
32	0,030	
40	0,060	
50	0,072	
63	0,178	

Cyl. Ø mm	A1*	A2**	B1*	B2**	C1*	C2**	D	E	F	G	H	I
12	42,0	-	50,0	-	54,4	-	3,5	12,7	17,0	25	13	33
20	44,5	-	51,0	-	57,5	-	3,5	12,7	22,0	35	20	43
25	48,5	63,5	58,0	73,0	64,5	79,5	4,5	16,0	23,0	41	27	51
32	49,3	67,3	58,7	76,7	65,3	83,3	4,5	16,0	27,0	19	32	46
40	53,7	71,7	66,5	84,5	75,2	93,2	6,5	19,0	31,5	21	40	56
50	58,7	76,7	71,5	89,5	80,3	98,3	6,5	19,0	37,0	27	50	66
63	69,0	89,0	88,0	108,0	99,0	119,0	8,5	25,4	43,0	34	62	83

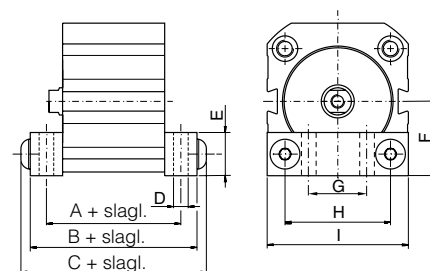

\* Double acting cylinders and single acting cylinders up to stroke length 30 mm

\*\* Single acting cylinders, stroke length 31 to 50 mm

## Cylinder mountings

Type	Description	Cyl. bore Ø mm	Mass kg	Order code
<b>Clevis</b>	According to ISO 8140 Intended for articulated mounting of the cylinder. This mounting is adjustable in the axial direction, and is supplied complete with shaft. Intended for use with the pin bolt.	20	0,011	<b>P1J-4HRC</b>
		25	0,011	<b>P1J-4HRC</b>
		32	0,022	<b>P1A-4DRC</b>
		40	0,022	<b>P1A-4DRC</b>
		50	0,045	<b>P1A-4HRC</b>
		63	0,045	<b>P1A-4HRC</b>

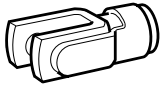

Material:  
Zinc plated steel

Cyl. Ø mm	A mm	B	C mm	D mm	E mm	F mm	G mm	H mm	I mm	J mm
20	5	M5	2,5	10	10	6	20	5	25	2,0
25	5	M5	2,5	10	10	6	20	5	25	2,0
32	6	M6	3,0	12	12	7	24	6	30	3,0
40	6	M6	3,0	12	12	7	24	6	30	3,0
50	8	M8	5,0	16	16	10	32	8	42	3,5
63	8	M8	5,0	16	16	10	32	8	42	3,5

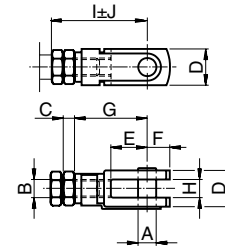

## Swivel rod eye

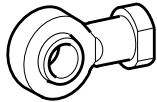

According to ISO 8139  
Intended for articulated mounting of the cylinder. This mounting is adjustable in the axial direction.

Material:  
Swivel rod eye: Zinc plated steel  
Swivel: tempered steel

12	0,008	<b>P1J-4DRS</b>
20	0,019	<b>P1J-4HRS</b>
25	0,019	<b>P1J-4HRS</b>
32	0,025	<b>P1A-4DRS</b>
40	0,025	<b>P1A-4DRS</b>
50	0,045	<b>P1A-4HRS</b>
63	0,045	<b>P1A-4HRS</b>

Cyl. Ø mm	A mm	B	C mm	D mm	E mm	F mm	G mm	H mm	I mm	J mm	L mm
12	3	M3	1,6	6	10	7	21	4,5	4,5	24,2	1,0
20	5	M5	2,5	8	10	9	27	6,0	7,5	34,5	1,0
25	5	M5	2,5	8	10	9	27	6,0	7,5	34,5	1,0
32	6	M6	3,0	9	10	10	30	6,8	9,0	38,5	1,5
40	6	M6	3,0	9	10	10	30	6,8	9,0	38,5	1,5
50	8	M8	5,0	12	12	12	36	9,0	12,0	49,0	2,0
63	8	M8	5,0	12	12	12	36	9,0	12,0	49,0	2,0

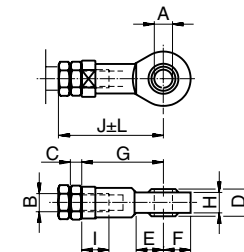

## Pin bolt

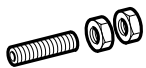

Intended for securing to the piston rod. The bolt can be combined with the swivel mount or clevis mount.

Material:  
Zinc plated steel

12	0,002	<b>P1J-6DS0</b>
20	0,005	<b>P1J-6HS0</b>
25	0,005	<b>P1J-6HS0</b>
32	0,008	<b>P1J-6KS0</b>
40	0,008	<b>P1J-6KS0</b>
50	0,014	<b>P1J-6MS0</b>
63	0,014	<b>P1J-6MS0</b>

Cyl. Ø mm	A mm	B mm	C mm	D mm	E
12	1,5	5,5	1,6	10	M3
20	2,5	8,0	2,5	20	M5
25	2,5	8,0	2,5	20	M5
32	3,0	10,0	3,0	25	M6
40	3,0	10,0	3,0	25	M6
50	4,0	13,0	5,0	25	M8
63	4,0	13,0	5,0	25	M8

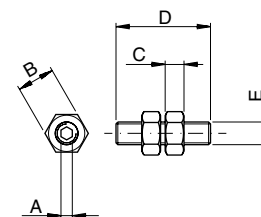

## P8S-DRFLX P8S-DPFLX

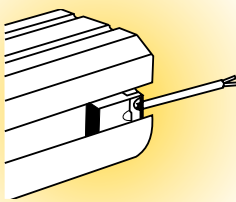

### Reed switch sensors

These sensors are based on a thoroughly proven reed switch, suitable for use at a wide range of voltages. This, together with the compact size and simple dovetail mounting, makes these sensors suitable for a wide range of applications. They can interface with electronic control systems, relay systems or conventional valves.

### Technical data

Specification	P8S-DRFLX, 3 m P8S-DRSHX
Type	Reed switch
Output	Normally open
Voltage range, P8S-DRFLX	0-110 VAC/VDC
Voltage range, P8S-DRSHX	0-60 VAC/VDC
Maximum voltage drop	2,8 V
Maximum load current	380 mA
Maximum interrupting capacity (resistive)	10 W
Minimum activation distance	11 mm
Repetition accuracy	±0,1 mm
Maximum operating frequency	500 Hz
Maximum response time	1 ms
Protection class	IP 67
Operating temperature range	-10 °C to +70 °C
Indication	LED, red
Material, sensor casing	Polyamide
Cable	PVC 2x0,2 mm <sup>2</sup>
Cable including female connector	PVC 3x0,2 mm <sup>2</sup>
Weight, sensor with 3 m cable	55 g
Weight, sensor with male connector	8 g
Weight, cable with connector, 3 m	90 g
Weight, cable with connector, 5 m	146 g
Weight, cable with connector, 10 m	286 g
Fitting	Dovetail

### Ordering data

Output	Cable length	Order code
<b>Reed switch sensors</b>		
Normally open	3 m*	<b>P8S-DRFLX</b>
Normally open	**	<b>P8S-DRSHX</b>

\* Moulded cable

\*\* Cable must be ordered separately.

### Symbols

P8S-DRFLX

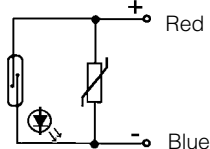

P8S-DRSHX

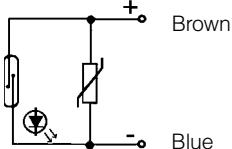

## P8S-DRSHX P8S-DPSHX

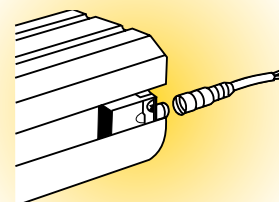

### Electronic sensors

The electronic sensors are solid state sensors with no moving parts, and include squelch and transient protection circuitry as standard. The integral electronics make these sensors suitable for use in applications with very high switching frequencies.

### Technical data

Specification	P8S-DPFLX, 3 m P8S-DPSHX
Type	Hall element
Output	PNP, N.O.
Voltage range	10-28 VDC
Maximum voltage drop	1 V
Maximum load current	See diagram below
Maximum interrupting capacity (resistive)	12 W
Minimum activation distance	12 mm
Repetition accuracy	±0,1 mm
Maximum operating frequency	1 kHz
Maximum response time	0,01 ms
Protection class	IP 67
Operating temperature range	-10 °C to +70 °C
Indication	LED, red
Material, sensor casing	Polyamide
Cable	PVC 2x0,2 mm <sup>2</sup>
Cable including female connector	PVC 3x0,2 mm <sup>2</sup>
Weight, sensor with 3 m cable	55 g
Weight, sensor with male connector	8 g
Weight, cable with connector, 3 m	90 g
Weight, cable with connector, 5 m	146 g
Weight, cable with connector, 10 m	286 g
Fitting	Dovetail

### Ordering data

Output	Cable length	Order code
<b>Electronic sensors</b>		
PNP, NO	3 m*	<b>P8S-DPFLX</b>
PNP, NO	**	<b>P8S-DPSHX</b>

### Maximum load current

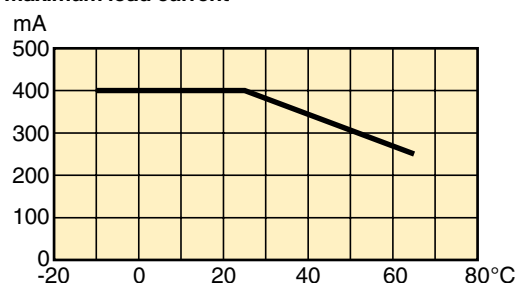

### Symbols

P8S-DPFLX

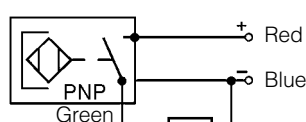

P8S-DPSHX

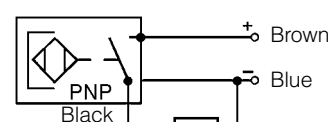

### Connecting cables with one connector

The cables have an integral snap-in female connector.



Type of cable	Cable/connector	Weight kg	Order code
<b>Cables for sensors, complete with one female connector</b>			
Cable, Flex PVC	3 m, 8 mm Snap-in connector	0,07	<b>9126344341</b>
Cable, Flex PVC	10 m, 8 mm Snap-in connector	0,21	<b>9126344342</b>
Cable, Super Flex PVC	3 m, 8 mm Snap-in connector	0,07	<b>9126344343</b>
Cable, Super Flex PVC	10 m, 8 mm Snap-in connector	0,21	<b>9126344344</b>
Cable, Polyurethane	3 m, 8 mm Snap-in connector	0,01	<b>9126344345</b>
Cable, Polyurethane	10 m, 8 mm Snap-in connector	0,20	<b>9126344346</b>
Cable, Polyurethane	5 m, M12 screw connector	0,07	<b>9126344348</b>
Cable, Polyurethane	10 m, M12 screw connector	0,20	<b>9126344349</b>

### Male connectors for connecting cables

Cable connectors for producing your own connecting cables. The connectors can be quickly attached to the cable without special tools. Only the outer sheath of the cable is removed. The connectors are available for M8 and M12 screw connectors and meet protection class IP 65.



Connector	Weight kg	Order code
M8 screw connector	0,017	<b>P8SCS0803J</b>
M12 screw connector	0,022	<b>P8SCS1204J</b>

### Ready to use connecting cables with connectors at each end

As accessories the system comprises a large number of different cables in order to meet all requirements that may arise and to make the installation simple, fast and reliable.

Cables with moulded 8 mm snap-in round contacts in both ends. The cables are available in two types, one with a straight male and female connectors respectively, and one with a straight 3-pole male connector in one end and an angled 3-pole female connector in the other end.



#### Technical data

##### Contacts

Moulded 8 mm snap-in male/female contacts.

Enclosure IP67

##### Cable

Conductor 3x0,25 mm<sup>2</sup> (32x0,10 mm<sup>2</sup>)  
 Sheath PVC/PUR  
 Colour Black

Cables with straight 3-pole male and female connectors respectively.

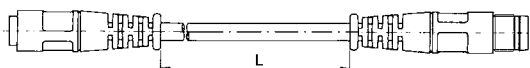

Cables with a straight 3-pole male connector in one end and an angled 3-pole female connector in the other end.



Designation	Weight kg	Order code
Cable with straight contacts, 0,2 m	0,02	<b>9121717014</b>
Cable with straight contacts, 0,3 m	0,02	<b>9121717015</b>
Cable with straight contacts, 0,5 m	0,03	<b>9121717016</b>
Cable with straight contacts, 1,0 m	0,03	<b>9121717017</b>
Cable with straight contacts, 2,0 m	0,05	<b>9121717018</b>
Cable with straight contacts, 3,0 m	0,07	<b>9121717019</b>
Cable with straight contacts, 5,0 m	0,12	<b>9121717020</b>
Cable with straight contacts, 10 m	0,23	<b>9121717021</b>

Designation	Weight kg	Order code
Cable with straight and angled connectors, 0,2 m	0,02	<b>9121717022</b>
Cable with straight and angled connectors, 0,3 m	0,02	<b>9121717023</b>
Cable with straight and angled connectors, 0,5 m	0,03	<b>9121717024</b>
Cable with straight and angled connectors, 1,0 m	0,03	<b>9121717025</b>
Cable with straight and angled connectors, 2,0 m	0,05	<b>9121717026</b>
Cable with straight and angled connectors, 3,0 m	0,07	<b>9121717027</b>
Cable with straight and angled connectors, 5,0 m	0,12	<b>9121717028</b>
Cable with straight and angled connectors, 10 m	0,23	<b>9121717029</b>



### Connection block Valvetronic 110

The Valvetronic 110 is a connection block that can be used for collecting signals from sensors at various points on a machine and connecting them to the control system via a multicore cable. Valvetronic 110 can also be used for central connection of the multi-core cable to the outputs of a control system, and can be laid to a machine where the output signals can be connected. The connection block has ten 8 mm snap-in circular connectors and a multi-core cable which is available in lengths of 3 or 10 m. The connections on the block are numbered from 1 to 10. Blanking plugs are available for unused connections, as labels for marking the connections of each block.



### Technical data

#### Connections:

Ten 3-pole numbered 8 mm round snap-in female contacts

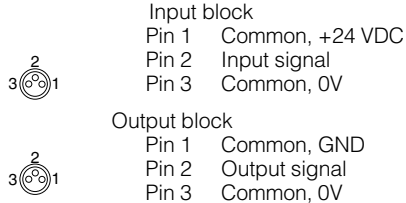

#### Electrical data:

Voltage 24 VDC (max. 60 V AC/75 V DC)  
 Insulation group according to DIN 0110 class C  
 Load max. 1 A per connection  
 total max. 3 A

#### Cable:

Length 3 m or 10 m  
 Type of cable LifYY11Y  
 Conductor 12  
 Area 0.34 mm<sup>2</sup>  
 Colour marking According to DIN 47 100

#### Mechanical data

Enclosure IP 67, DIN 40050 with fitted contacts and/or blanking plugs.  
 Temperature -20 °C to +70 °C



#### Material

Body PA 6,6 VD according to UL 94  
 Contact holder PBTP  
 Snap-in ring LDPE  
 Moulding mass Epoxy  
 Seal NBR  
 Screws Plated steel

#### Industrial durability

Good chemical and oil resistance. Tests should be performed in aggressive environments.

### Ordering data

Designation	Weight kg	Order code
 Connection block Valvetronic 110 with 3 m cable	0,32	<b>9121719001</b>
Connection block Valvetronic 110 with 10 m cable	0,95	<b>9121719002</b>
 Blanking plugs (pack of 10) Use blanking plugs to close unused connections.	0,02	<b>9121719003</b>
 Labels (pack of 10) White labels to insert in grooves on the side of the connection	0,02	<b>9121719004</b>

### Dimensions and wiring diagrams

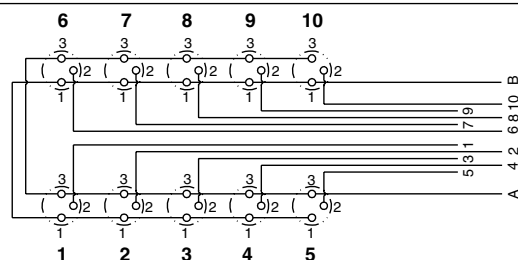
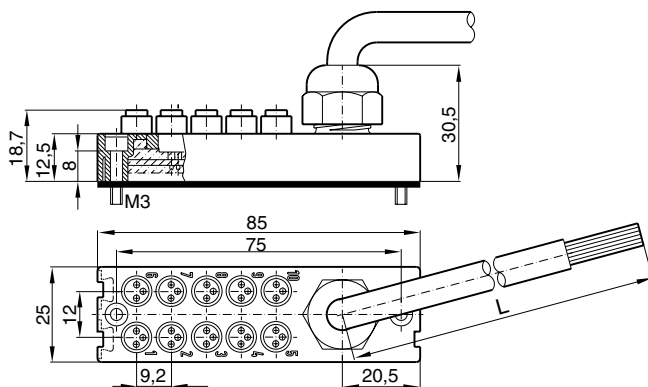

Conductor	Colour	Input	Output
1	Pink	Signal 1	Signal 1
2	Grey	Signal 2	Signal 2
3	Yellow	Signal 3	Signal 3
4	Green	Signal 4	Signal 4
5	White	Signal 5	Signal 5
6	Red	Signal 6	Signal 6
7	Black	Signal 7	Signal 7
8	Violet	Signal 8	Signal 8
9	Grey-Pink	Signal 9	Signal 9
10	Red-Blue	Signal 10	Signal 10
A	Blue	0 V	0 V
B	Brown	+24 V	PE





# Parker Worldwide

## Europe, Middle East, Africa

**AE – United Arab Emirates,** Dubai

Tel: +971 4 8127100  
parker.me@parker.com

**AT – Austria,** Wiener Neustadt

Tel: +43 (0)2622 23501-0  
parker.austria@parker.com

**AT – Eastern Europe,** Wiener Neustadt

Tel: +43 (0)2622 23501 900  
parker.easteurope@parker.com

**AZ – Azerbaijan,** Baku

Tel: +994 50 2233 458  
parker.azerbaijan@parker.com

**BE/LU – Belgium,** Nivelles

Tel: +32 (0)67 280 900  
parker.belgium@parker.com

**BY – Belarus,** Minsk

Tel: +375 17 209 9399  
parker.belarus@parker.com

**CH – Switzerland,** Etoy

Tel: +41 (0)21 821 87 00  
parker.switzerland@parker.com

**CZ – Czech Republic,** Klecany

Tel: +420 284 083 111  
parker.czechrepublic@parker.com

**DE – Germany,** Kaarst

Tel: +49 (0)2131 4016 0  
parker.germany@parker.com

**DK – Denmark,** Ballerup

Tel: +45 43 56 04 00  
parker.denmark@parker.com

**ES – Spain,** Madrid

Tel: +34 902 330 001  
parker.spain@parker.com

**FI – Finland,** Vantaa

Tel: +358 (0)20 753 2500  
parker.finland@parker.com

**FR – France,** Contamine s/Arve

Tel: +33 (0)4 50 25 80 25  
parker.france@parker.com

**GR – Greece,** Athens

Tel: +30 210 933 6450  
parker.greece@parker.com

**HU – Hungary,** Budapest

Tel: +36 1 220 4155  
parker.hungary@parker.com

**IE – Ireland,** Dublin

Tel: +353 (0)1 466 6370  
parker.ireland@parker.com

**IT – Italy,** Corsico (MI)

Tel: +39 02 45 19 21  
parker.italy@parker.com

**KZ – Kazakhstan,** Almaty

Tel: +7 7272 505 800  
parker.easteurope@parker.com

**NL – The Netherlands,** Oldenzaal

Tel: +31 (0)541 585 000  
parker.nl@parker.com

**NO – Norway,** Asker

Tel: +47 66 75 34 00  
parker.norway@parker.com

**PL – Poland,** Warsaw

Tel: +48 (0)22 573 24 00  
parker.poland@parker.com

**PT – Portugal,** Leca da Palmeira

Tel: +351 22 999 7360  
parker.portugal@parker.com

**RO – Romania,** Bucharest

Tel: +40 21 252 1382  
parker.romania@parker.com

**RU – Russia,** Moscow

Tel: +7 495 645-2156  
parker.russia@parker.com

**SE – Sweden,** Spånga

Tel: +46 (0)8 59 79 50 00  
parker.sweden@parker.com

**SK – Slovakia,** Banská Bystrica

Tel: +421 484 162 252  
parker.slovakia@parker.com

**SL – Slovenia,** Novo Mesto

Tel: +386 7 337 6650  
parker.slovenia@parker.com

**TR – Turkey,** Istanbul

Tel: +90 216 4997081  
parker.turkey@parker.com

**UA – Ukraine,** Kiev

Tel: +380 44 494 2731  
parker.ukraine@parker.com

**UK – United Kingdom,** Warwick

Tel: +44 (0)1926 317 878  
parker.uk@parker.com

**ZA – South Africa,** Kempton Park

Tel: +27 (0)11 961 0700  
parker.southafrica@parker.com

## North America

**CA – Canada,** Milton, Ontario

Tel: +1 905 693 3000

**US – USA,** Cleveland

Tel: +1 216 896 3000

## Asia Pacific

**AU – Australia,** Castle Hill

Tel: +61 (0)2-9634 7777

**CN – China,** Shanghai

Tel: +86 21 2899 5000

**HK – Hong Kong**

Tel: +852 2428 8008

**IN – India,** Mumbai

Tel: +91 22 6513 7081-85

**JP – Japan,** Tokyo

Tel: +81 (0)3 6408 3901

**KR – South Korea,** Seoul

Tel: +82 2 559 0400

**MY – Malaysia,** Shah Alam

Tel: +60 3 7849 0800

**NZ – New Zealand,** Mt Wellington

Tel: +64 9 574 1744

**SG – Singapore**

Tel: +65 6887 6300

**TH – Thailand,** Bangkok

Tel: +662 186 7000 99

**TW – Taiwan,** Taipei

Tel: +886 2 2298 8987

## South America

**AR – Argentina,** Buenos Aires

Tel: +54 3327 44 4129

**BR – Brazil,** Sao Jose dos Campos

Tel: +55 800 727 5374

**CL – Chile,** Santiago

Tel: +56 2 623 1216

**MX – Mexico,** Apodaca

Tel: +52 81 8156 6000

European Product Information Centre

Free phone: 00 800 27 27 5374

(from AT, BE, CH, CZ, DE, DK, EE, ES, FI, FR, IE, IL, IS, IT, LU, MT, NL, NO, PL, PT, RU, SE, SK, UK, ZA)

## Parker Hannifin Manufacturing Ltd

Pneumatic Division Europe  
The Collins Centre,  
Lichfield South, Wall Island,  
Birmingham Road, Lichfield.  
WS14 0QP United Kingdom  
Tel.: +44 (0) 1543 483800  
Fax: +44 (0) 1543 483801  
www.parker.com

